

Q00018

SAE 100R7/R8软管套筒
Ferrule For SAE 100 R7/R8 Hose



代号 PART NO.	软管 HOSE BORE		尺寸 DIMENSIONS	
	公称内径 DN	标号 DASH	L	D
Q00018-02	4	02	25	13.5
Q00018-03	5	03	27	15
Q00018-04	6	04	30	18
Q00018-04A	6	04	29	14
Q00018-05	8	05	30	18.8
Q00018-06	10	06	34	21
Q00018-08	13	08	34	25.5
Q00018-08A	13	08	34	27.2
Q00018-10	16	10	37	31.5
Q00018-10A	16	10	37	28.6
Q00018-12	19	12	43	33

Q00100

GB 3863 1型,DIN 20022 1ST,SAE 100 R1A软管套筒
For GB3863 1Type,DIN 20022 1ST,SAE 100 R1A Hose Ferrule

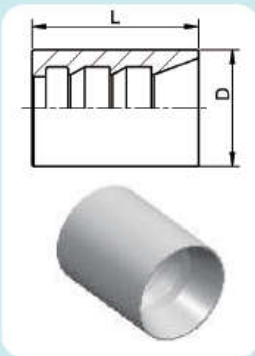

代号 PART NO.	软管 HOSE BORE		尺寸 DIMENSIONS	
	公称内径 DN	标号 DASH	L	D
Q00100-04	6	04	30	20
Q00100-05	8	05	31	21
Q00100-06	10	06	32	23
Q00100-08	13	08	34	28.5
Q00100-10	16	10	37	32
Q00100-12	19	12	42	35
Q00100-16	25	16	50	43
Q00100-20	32	20	59	50.5
Q00100-24	38	24	72	57
Q00100-32	51	32	74	70

Q00200

GB 3863 2型,DIN 20022 2ST,SAE 100 R2A软管套筒
For GB3863 2 Type DIN 20022 2ST,SAE 100 R2A Hose Ferrule

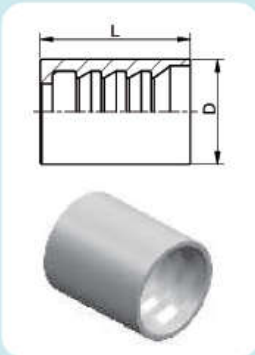

代号 PART NO.	软管 HOSE BORE		尺寸 DIMENSIONS	
	公称内径 DN	标号 DASH	L	D
Q00200-04	6	04	30	21
Q00200-05	8	05	31	22.5
Q00200-06	10	06	32	24
Q00200-08	13	08	34	28.7
Q00200-10	16	10	37	31.5
Q00200-12	19	12	43	36
Q00200-16	25	16	50	44
Q00200-20	32	20	59	54.5
Q00200-24	38	24	74	62
Q00200-32	51	32	78	75

Q00110A

改进型 SAE 100RIAT/DIN 20022 1SN软管套筒
Ferrule For SAE 100RIAT/DIN 20022 1SN HOSE

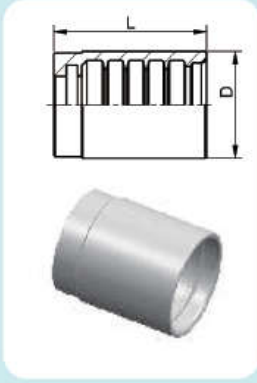

代号 PART NO.	软管 HOSE BORE		尺寸 DIMENSIONS	
	公称内径 DN	标号 DASH	L	D
Q00110-04A	6	04	30	21
Q00110-05A	8	05	31	21.8
Q00110-06A	10	06	32	24.3
Q00110-08A	13	08	34	28.4
Q00110-10A	16	10	37	32
Q00110-12A	19	12	43	35.5
Q00110-16A	25	16	50	44
Q00110-20A	32	20	59	53
Q00110-24A	38	24	74	59.3
Q00110-32A	51	32	78	73.5

Q00110

SAE 100RIAT/DIN 20022 1SN软管套筒
Ferrule For SAE 100RIAT/DIN 20022 1SN HOSE

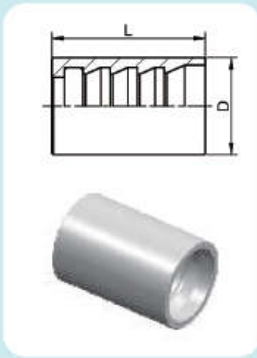

代号 PART NO.	软管 HOSE BORE		尺寸 DIMENSIONS	
	公称内径 DN	标号 DASH	L	D
Q00110-04	6	04	30	20.6
Q00110-05	8	05	31	20.8
Q00110-06	10	06	32	23.3
Q00110-08	13	08	34	27
Q00110-10	16	10	37	32
Q00110-12	19	12	43	34
Q00110-16	25	16	50	42.6
Q00110-20	32	20	59	52
Q00110-24	38	24	74	58
Q00110-32	51	32	78	72

Q00210

GB 3863 2型,DIN 20022 2ST,SAE 100 R2AT软管套筒
For GB3863 2 Type,DIN 20022 2ST,SAE 100 R2AT Hose Ferrule

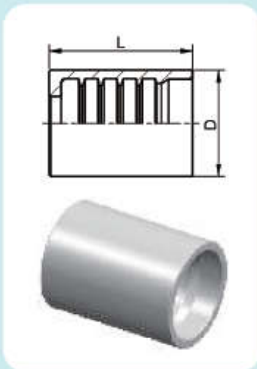

代号 PART NO.	软管 HOSE BORE		尺寸 DIMENSIONS	
	公称内径 DN	标号 DASH	L	D
Q00210-04	6	04	30	22.3
Q00210-05	8	05	31	23
Q00210-06	10	06	32	25
Q00210-08	13	08	34	28.7
Q00210-10	16	10	37	31.5
Q00210-12	19	12	43	35.5
Q00210-16	25	16	50	45
Q00210-20	32	20	59	55
Q00210-24	38	24	74	62.5
Q00210-32	51	32	78	75.5

注: 不推荐用于工程机械类。 Don't recommend for engineering machine.

Q03310

SAE R2AT, DIN 20022 2SN 软管套筒
Ferrule For SAE R2AT DIN 20022 2SN HOSE

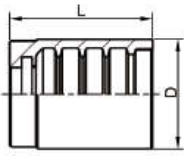

代号 PART NO.	软管 HOSE BORE		尺寸 DIMENSIONS	
	公称内径 DN	标号 DASH	L	D
QS03310-04	6	04	30	23.2
QS03310-05	8	05	30	24
QS03310-06	10	06	32	26.3
QS03310-08	13	08	34	29.9
QS03310-10	16	10	36	33.2
QS03310-12	19	12	42	37.8
QS03310-16	25	16	50	46.9
QS03310-20	32	20	59	59
QS03310-24	38	24	72	67
QS03310-32	51	32	75	80

Q01100

国产一层钢丝编织软管套筒
Ferrule For China Standard 1-steel Wire Braid Hose

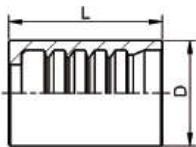

代号 PART NO.	软管 HOSE BORE		尺寸 DIMENSIONS	
	公称内径 DN	标号 DASH	L	D
Q01100-04	6	04	30	19
Q01100-05	8	05	32	21
Q01100-06	10	06	32	23
Q01100-08	13	08	34	28
Q01100-10	16	10	37	31
Q01100-12	19	12	43	34
Q01100-16	25	16	50	41
Q01100-20	32	20	59	49
Q01100-24	38	24	74	55

Q01200

国产二层钢丝编织软管套筒
Ferrule For China Standard 2-steel Wire Braid Hose

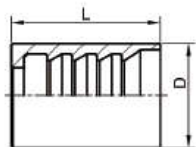

代号 PART NO.	软管 HOSE BORE		尺寸 DIMENSIONS	
	公称内径 DN	标号 DASH	L	D
Q01200-04	6	04	30	21
Q01200-05	8	05	31	23
Q01200-06	10	06	32	25
Q01200-08	13	08	34	31
Q01200-10	16	10	39	34
Q01200-12	19	12	43	37
Q01200-16	25	16	50	43
Q01200-20	32	20	59	51
Q01200-24	38	24	74	57

Q01300

国产三层钢丝编织软管套筒

Ferrule For China Standard 3-steel Wire Braid Hose

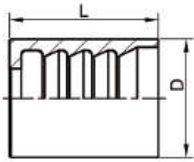

代号 PART NO.	软管 HOSE BORE		尺寸 DIMENSIONS	
	公称内径 DN	标号 DASH	L	D
Q01300-05	8	05	32	25.5
Q01300-08	13	08	34	33
Q01300-10	16	10	39	36
Q01300-12	19	12	43	39
Q01300-16	25	16	50	45
Q01300-20	32	20	59	53
Q01300-24	38	24	74	59
Q01300-32	51	32	78	72

Q01400

SAE 100 R12/20-24, GB 10544 5型 软管套筒

Ferrule For SAE 100R 12/20-24, GB 10544 Ty5pe Hose

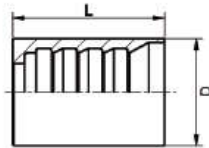

代号 PART NO.	软管 HOSE BORE		尺寸 DIMENSIONS	
	公称内径 DN	标号 DASH	L	D
Q01400-06	10	06	39	27.5
Q01400-08	13	08	41	31.5
Q01400-10	16	10	43	34
Q01400-12	19	12	51	39
Q01400-16	25	16	61.5	46.5
Q01400-20	32	20	67.5	55.5
Q01400-24	38	24	75	63.5
Q01400-32	51	32	79	78

Q00400

SAE 100 R12/06-16 GB 10544 3型/20-32, DIN 20023-4SP,4SH/10-16 软管套筒

Ferrule For SAE 100 R12/06-16, GB 10544 3 Type/20-32, DIN 20023-4SP,4SH/10-16 Hose

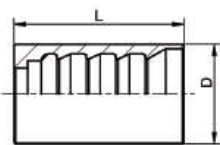

代号 PART NO.	软管 HOSE BORE		尺寸 DIMENSIONS	
	公称内径 DN	标号 DASH	L	D
Q00400-04	6	04	37.5	22
Q00400-06	10	06	39	25.5
Q00400-08	13	08	41	29
Q00400-10	16	10	43	34
Q00400-12	19	12	51	37
Q00400-16	25	16	61.5	46.5
Q00400-20	32	20	67.5	57
Q00400-24	38	24	75	65
Q00400-32	51	32	79	79

Q00401

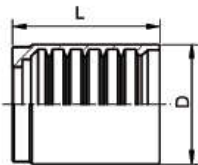
DIN 20023-4SH 软管套筒
Ferrule For DIN 20023-4SH Hose

代号 PART NO.	软管 HOSE BORE		尺寸 DIMENSIONS	
	公称内径 DN	标号 DASH	L	D
Q00401-20	32	20	67.5	53
Q00401-24	38	24	75	61
Q00401-32	51	32	79	77

Q00621

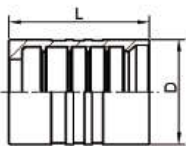
SAE 100 R13/R15 4,SH/12-16 软管剥内外胶套筒
Interlock Ferrule For SAE 100 R13/R15 4,SH/12-16 Hose

代号 PART NO.	软管 HOSE BORE		尺寸 DIMENSIONS	
	公称内径 DN	标号 DASH	L	D
Q00621-12	19	12	53	39.5
Q00621-16	25	15	66	48.5
Q00621-20	32	20	88	59
Q00621-24	38	24	102	69.3
Q00621-32	51	32	106	84.45

Q10411

公制外螺纹24°内锥面轻系列
Metric Male 24° Cone Sest L.T.ISO 12151-2 -DIN3861

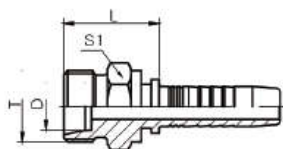

代号 PART NO.	螺纹T	软管 HOSE BORE		管子外径	尺寸 DIMENSIONS		
	THREAD T	公称内径DN	标号 DASH	TUBE O.D	L	D	S1
Q10411-12-04	M12X1.5	6	04	6	20.5	6	14
Q10411-14-04	M14X1.5	6	04	8	20.5	8	17
Q10411-14-05	M14X1.5	8	05	8	21.5	8	17
Q10411-16-04	M16X1.5	6	04	10	22.5	10	17
Q10411-16-05	M16X1.5	8	05	10	22.5	10	17
Q10411-16-06	M16X1.5	10	06	10	23.5	10	17
Q10411-18-05	M18X1.5	8	05	12	23.5	12	19
Q10411-18-06	M18X1.5	10	06	12	23.5	12	19
Q10411-22-06	M22X1.5	10	06	15	24.5	15	24
Q10411-22-08	M22X1.5	13	08	15	25	15	24
Q10411-26-08	M26X1.5	13	08	18	26.5	18	27
Q10411-26-10	M26X1.5	16	10	18	27	18	27
Q10411-30-10	M30X2	16	10	22	30	22	32
Q10411-30-12	M30X2	19	12	22	30	22	32
Q10411-36-16	M36X2	25	16	28	33	28	41
Q10411-45-20	M45X2	32	20	35	38	35	46
Q10411-52-24	M52X2	38	24	42	38.5	42	55

注：1、表中代号用于编织软管。2、如需用于缠绕软管代号改为Q10412-XX-XX。 Note:1.For use with braided hoses. 2.If use with spiral hoses,hose fitting series number is Q10412-XX-XX.

Q20411-W

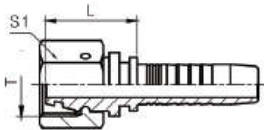

Q20411-T

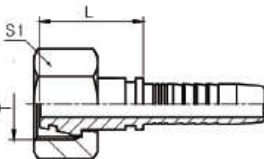

公制外螺纹24°锥带O型轻系列
Metric Female 24° Cone O-Ring L.T. ISO 12151-2-DIN3865

代号 PART NO.	螺纹T	软管 HOSE BORE		管子外径	尺寸 DIMENSIONS		
	THREAD T	公称内径DN	标号 DASH	TUBE O.D	L	H	S1
Q20411-12-04W	M12X1.5	6	04	6	39.8	16	14
Q20411-14-04T	M14X1.5	6	04	8	39.8	16	17
Q20411-14-05W	M14X1.5	8	05	8	40.7	17	17
Q20411-14-06W	M14X1.5	10	06	8	44.5	18.5	17
Q20411-16-04T	M16X1.5	6	04	10	40.8	17	19
Q20411-16-05T	M16X1.5	8	05	10	40.7	17	19
Q20411-16-06W	M16X1.5	10	06	10	44.5	18.5	19
Q20411-18-05T	M18X1.5	8	05	12	42.2	18.5	22
Q20411-18-06T	M18X1.5	10	06	12	44.5	18.5	22
Q20411-18-08W	M18X1.5	13	08	12	50.8	19.5	22
Q20411-22-08T	M22X1.5	13	08	15	50.8	19.5	27
Q20411-22-10W	M22X1.5	16	10	15	62.7	23.5	27
Q20411-26-10T	M26X1.5	16	10	18	62.7	23.5	32
Q20411-26-12W	M26X1.5	19	12	18	68.2	25.5	32
Q20411-30-10T	M30X2	16	10	22	64.7	25.5	36
Q20411-30-12T	M30X2	19	12	22	68.2	25.5	36
Q20411-30-16W	M30X2	25	16	22	81.4	32	36
Q20411-36-12T	M36X2	19	12	28	74.7	32	41
Q20411-36-14T	M36X2	22	14	28	79.5	34	41
Q20411-36-16T	M36X2	25	16	28	81.4	32	41
Q20411-36-20W	M36X2	32	20	28	98.8	38	41
Q20411-45-16T	M45X2	25	16	35	87.4	38	50
Q20411-45-20T	M45X2	32	20	35	98.8	38	50
Q20411-45-24W	M45X2	38	24	35	115.6	44.5	50
Q20411-52-20T	M52X2	32	20	42	105.3	44.5	60
Q20411-52-24T	M52X2	38	24	42	115.6	44.5	60
Q20411-52-32W	M52X2	51	32	42	137.6	57.6	60

注：1、表中代号用于编织软管。2、如需用于缠绕软管代号改为Q20412-XX-XX。 Note:1.For use with braided hoses. 2.If use with spiral hoses,hose fitting series number is Q20412-XX-XX.

Q20441-W

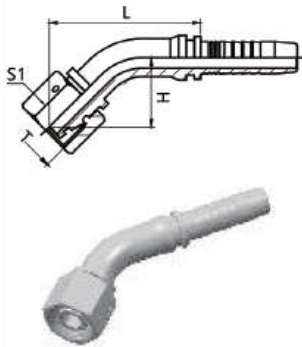

Q20441-T

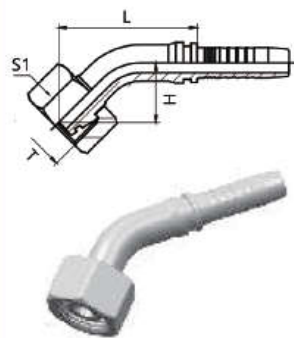

45°弯公制内螺纹24°锥带O型轻系列

45° Metric Female 24° Cone O-Ring L.T.ISO 12151-2-DIN3865

代号 PART NO.	螺纹T THREAD T	软管 HOSE BORE		管子外径 TUBE O.D	尺寸 DIMENSIONS		
		公称内径DN	标号 DASH		L	H	S1
Q20441-12-04W	M12X1.5	6	04	6	47	25	14
Q20441-14-04T	M14X1.5	6	04	8	39	17	17
Q20441-14-05W	M14X1.5	8	05	8	42.5	19	17
Q20441-14-06W	M14X1.5	10	06	8	45	19	17
Q20441-16-04T	M16X1.5	6	04	10	39	19	19
Q20441-16-05T	M16X1.5	8	05	10	45	21.5	19
Q20441-16-06W	M16X1.5	10	06	10	54.6	28.6	19
Q20441-18-05T	M18X1.5	8	05	12	46	22	22
Q20441-18-06T	M18X1.5	10	06	12	48	22.2	22
Q20441-18-08W	M18X1.5	13	08	12	54	21.5	22
Q20441-22-08T	M22X1.5	13	08	15	57	25	27
Q20441-22-10W	M22X1.5	16	10	15	73	33.7	27
Q20441-26-10T	M26X1.5	16	10	18	68.5	29	32
Q20441-26-12W	M26X1.5	19	12	18	81	38.5	32
Q20441-30-10T	M30X2	16	10	22	68	28.5	36
Q20441-30-12T	M30X2	19	12	22	74	31.5	36
Q20441-30-16W	M30X2	25	16	22	89.5	36.5	36
Q20441-36-12T	M36X2	19	12	28	76.5	33.7	41
Q20441-36-14T	M36X2	22	14	28	79.5	34	41
Q20441-36-16T	M36X2	25	16	28	88	35	41
Q20441-36-20W	M36X2	32	20	28	102	41.5	41
Q20441-45-16T	M45X2	25	16	35	88	35	50
Q20441-45-20T	M45X2	32	20	35	99.8	39.1	50
Q20441-45-24W	M45X2	38	24	35	113.5	44.5	50
Q20441-52-20T	M52X2	32	20	42	100	39.1	60
Q20441-52-24T	M52X2	38	24	42	115	45.3	60
Q20441-52-32W	M52X2	51	32	42	132.5	51.5	60

注：1、表中代号用于编织软管。2、如需用于缠绕软管代号改为Q20442-XX-XX。 Note: 1. For use with braided hoses. 2. If use with spiral hoses, hose fitting series number is Q20442-XX-XX.

Q20491-W

90°弯公制外螺纹24°锥带O型轻系列

90° Metric Female 24° Cone O-Ring L.T.ISO 12151-2-DIN3865

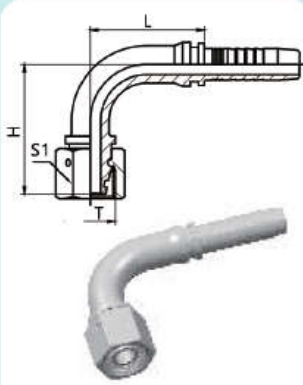

Q20491-T

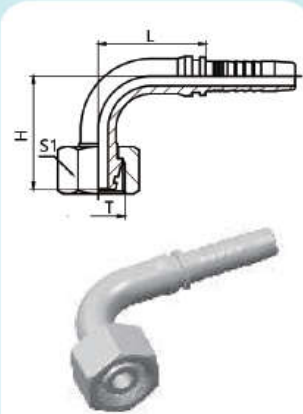

代号 PART NO.	螺纹T	软管 HOSE BORE		管子外径	尺寸 DIMENSIONS		
	THREAD T	公称内径DN	标号 DASH	TUBE O.D	L	H	S1
Q20491-12-04W	M12X1.5	6	04	6	32	30.5	14
Q20491-14-04T	M14X1.5	6	04	8	32	30.5	17
Q20491-14-05W	M14X1.5	8	05	8	32.5	33	17
Q20491-14-06W	M14X1.5	10	06	8	36.5	36	17
Q20491-16-04T	M16X1.5	6	04	10	32	33	19
Q20491-16-05T	M16X1.5	8	05	10	32.5	33	19
Q20491-16-06W	M16X1.5	10	06	10	36.5	36	19
Q20491-18-05T	M18X1.5	8	05	12	32.5	36	22
Q20491-18-06T	M18X1.5	10	06	12	36.5	36	22
Q20491-18-08W	M18X1.5	13	08	12	44.5	40.5	22
Q20491-22-08T	M22X1.5	13	08	15	44.5	40.5	27
Q20491-22-10W	M22X1.5	16	10	15	55	51.5	27
Q20491-26-10T	M26X1.5	16	10	18	55	51.5	32
Q20491-26-12W	M26X1.5	19	12	18	62	56	32
Q20491-30-10T	M30X2	16	10	22	55	56	36
Q20491-30-12T	M30X2	19	12	22	62	56	36
Q20491-30-16W	M30X2	25	16	22	74	68.5	36
Q20491-36-12T	M36X2	19	12	28	62	68.5	41
Q20491-36-16T	M36X2	25	16	28	74	68.5	41
Q20491-36-20W	M36X2	32	20	28	91.5	78.5	41
Q20491-45-16T	M45X2	25	16	35	74	78.5	50
Q20491-45-20T	M45X2	32	20	35	91.5	78.5	50
Q20491-45-24W	M45X2	38	24	35	108	95	50
Q20491-52-20T	M52X2	32	20	42	91.5	78.5	60
Q20491-52-24T	M52X2	38	24	42	108	95	60
Q20491-52-32W	M52X2	51	32	42	133.8	130.5	60

注：1、表中代号用于编织软管。2、如需用于缠绕软管代号改为Q20492-XX-XX。 Note:1.For use with braided hoses. 2.If use with spiral hoses,hose fitting series number is Q20492-XX-XX.

Q10511

公制外螺纹24°内锥面重系列

Metric Male 24° Cone H.T.ISO 84341-2-DIN3861

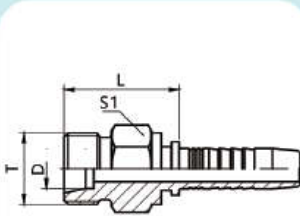

代号 PART NO.	螺纹T THREAD T	软管 HOSE BORE		管子外径 TUBE O.D	尺寸 DIMENSIONS		
		公称内径DN	标号 DASH		L	D	S1
Q10511-14-04	M14X1.5	6	04	6	24	6	14
Q10511-16-04	M16X1.5	6	04	8	26.5	8	17
Q10511-18-04	M18X1.5	6	04	10	26.5	10	19
Q10511-18-06	M18X1.5	10	06	10	27	10	19
Q10511-20-05	M20X1.5	8	05	12	28	12	22
Q10511-20-06	M20X1.5	10	06	12	28	12	22
Q10511-22-06	M22X1.5	10	06	14	28.5	14	24
Q10511-24-08	M24X1.5	13	08	16	32	16	27
Q10511-30-10	M30X2	16	10	20	36	20	32
Q10511-30-12	M30X2	19	12	20	36	20	32
Q10511-36-12	M36X2	19	12	25	40	25	41
Q10511-36-16	M36X2	25	16	25	41	25	41
Q10511-42-16	M42X2	25	16	30	43	30	46
Q10511-52-20	M52X2	32	20	38	48	38	55

注：1、表中代号用于编织软管。2、如需用于缠绕软管代号改为Q10512-XX-XX。 Note:1.For use with braided hoses. 2.If use with spiral hoses,hose fitting series number is Q10512-XX-XX.

Q20511-W

公制内螺纹24°锥带O型圈重系列

Metric Female 24° Cone O-Ring H.T. ISO 12151-2-DIN3865

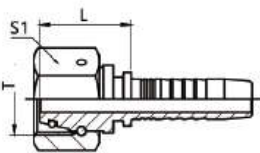

Q20511-T

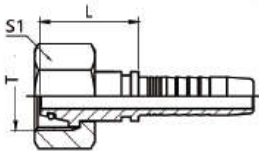

代号 PART NO.	螺纹T THREAD T	软管 HOSE BORE		管子外径 TUBE O.D	尺寸 DIMENSIONS		
		公称内径DN	标号 DASH		L	D	S1
Q 20511-14-04T	M14X1.5	6	04	6	23.5		17
Q 20511-16-04T	M16X1.5	6	04	8	24		19
Q 20511-16-05T	M16X1.5	8	05	8	24		19
Q 20511-18-04T	M18X1.5	6	04	10	25		22
Q 20511-18-05T	M18X1.5	8	05	10	25		22
Q 20511-18-06T	M18X1.5	10	06	10	25		22
Q 20511-20-06T	M20X1.5	10	06	12	28.5		24
Q 20511-20-08W	M20X1.5	13	08	12	29		24
Q 20511-22-06T	M22X1.5	10	06	14	25.5		27
Q 20511-24-06T	M24X1.5	10	06	16	29.5		30
Q 20511-24-08T	M24X1.5	13	08	16	30		30
Q 20511-30-10T	M30X2	16	10	20	34		36
Q 20511-30-12T	M30X2	19	12	20	35		36
Q 20511-36-12T	M36X2	19	12	25	32		46
Q 20511-36-16T	M36X2	25	16	25	35.5		46
Q 20511-42-12T	M42X2	19	12	30	35		50
Q 20511-42-16T	M42X2	25	16	30	36		50
Q 20511-42-20W	M42X2	32	20	30	34.5		50
Q 20511-52-20T	M52X2	32	20	38	36		60
Q 20511-52-24T	M52X2	38	24	38	36		60

注：1、表中代号用于编织软管。2、如需用于缠绕软管代号改为Q20512-XX-XX。 Note:1.For use with braided hoses. 2.If use with spiral hoses,hose fitting series number is Q20512-XX-XX.

Q20541-W

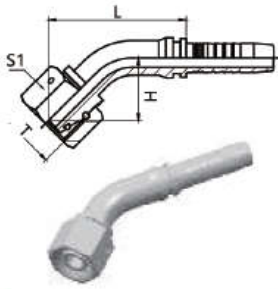

Q20541-T



45°公制内螺纹24°锥带O型圈重系列

45° Metric Female 24° Cone O-Ring H.T. ISO 12151-2-DIN3865

代号 PART NO.	螺纹T THREAD T	软管 HOSE BORE		管子外径 TUBE O.D	尺寸 DIMENSIONS		
		公称内径DN	标号 DASH		L	H	S1
Q 20541-14-04T	M14X1.5	6	04	6	40.8	17	17
Q 20541-16-04T	M16X1.5	6	04	8	40.8	17	19
Q 20541-16-05T	M16X1.5	8	05	8	41.7	18	19
Q 20541-18-04T	M18X1.5	6	04	10	40.8	17	22
Q 20541-18-05T	M18X1.5	8	05	10	41.7	18	22
Q 20541-18-06T	M18X1.5	10	06	10	44.5	18.5	22
Q 20541-20-06T	M20X1.5	10	06	12	44.5	18.5	24
Q 20541-20-08W	M20X1.5	13	08	12	52.3	21	24
Q 20541-22-06T	M22X1.5	10	06	14	48.9	22.9	27
Q 20541-24-06T	M24X1.5	10	06	16	44.5	18.5	30
Q 20541-24-08T	M24X1.5	13	08	16	52.3	21	30
Q 20541-30-10T	M30X2	16	10	20	64.2	25	36
Q 20541-30-12T	M30X2	19	12	20	73.2	30.5	36
Q 20541-36-12T	M36X2	19	12	25	73.2	30.5	46
Q 20541-36-16T	M36X2	25	16	25	84.9	35.5	46
Q 20541-42-12T	M42X2	19	12	30	78.2	35.5	50
Q 20541-42-16T	M42X2	25	16	30	84.9	35.5	50
Q 20541-42-20W	M42X2	32	20	30	102.75	42	50
Q 20541-52-20T	M52X2	32	20	38	102.75	42	60
Q 20541-52-24T	M52X2	38	24	38	115.7	44.6	60

注：1、表中代号用于编织软管。2、如需用于缠绕软管代号改为Q20542-XX-XX。 Note:1.For use with braided hoses. 2.If use with spiral hoses,hose fitting series number is Q20542-XX-XX.

Q20591-W

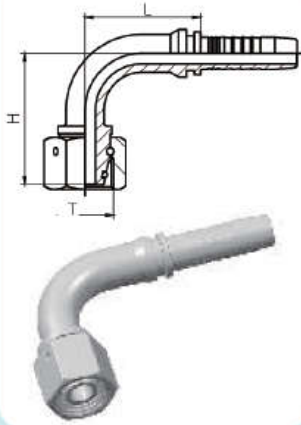

Q20591-T

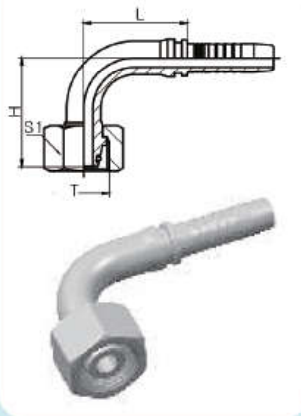

90°公制内螺纹24°锥带O型圈重系列

90°Metric Female 24°Cone O-Ring H.T. ISO 12151-2-DIN3865

代号 PART NO.	螺纹T	软管 HOSE BORE		管子外径	尺寸 DIMENSIONS		
	THREAD T	公称内径DN	标号 DASH	TUBE O.D	L	H	S1
Q20591-14-04T	M14X1.5	6	04	6	32	32	17
Q20591-16-04T	M16X1.5	6	04	8	32	32	19
Q20591-16-05T	M16X1.5	8	05	8	32.5	34	19
Q20591-18-04T	M18X1.5	6	04	10	32	32	22
Q20591-18-05T	M18X1.5	8	05	10	32.5	34	22
Q20591-18-06T	M18X1.5	10	06	10	36.5	35.5	22
Q20591-20-06T	M20X1.5	10	06	12	36.5	35.5	24
Q20591-20-08W	M20X1.5	13	08	12	44.5	43	24
Q20591-22-06T	M22X1.5	10	06	14	36.5	43	27
Q20591-24-06T	M24X1.5	10	06	16	44.5	43	30
Q20591-24-08T	M24X1.5	13	08	16	44.5	43	30
Q20591-30-10T	M30X2	16	10	20	55	49.5	36
Q20591-30-12T	M30X2	19	12	20	62	59	36
Q20591-36-12T	M36X2	19	12	25	62	59	46
Q20591-36-16T	M36X2	25	16	25	74	70	46
Q20591-42-12T	M42X2	19	12	30	74	70	50
Q20591-42-16T	M42X2	25	16	30	74	70	50
Q20591-42-20W	M42X2	32	20	30	91.5	87	50
Q20591-52-20T	M52X2	32	20	38	91.5	87	60
Q20591-52-24T	M52X2	38	24	38	108	100	60

注：1、表中代号用于编织软管。2、如需用于缠绕软管代号改为Q20592-XX-XX。 Note:1.For use with braided hoses. 2.If use with spiral hoses,hose fitting series number is Q20592-XX-XX.

Q20111

公制内螺纹球面
Metric Female Multiseal

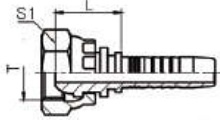

Q20111-T

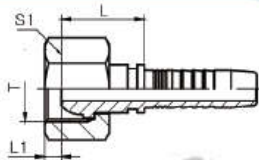

代号 PART NO.	螺纹T THREAD T	软管 HOSE BORE		尺寸 DIMENSIONS			
		公称内径DN	标号 DASH	L			S1
Q20111-12-04	M12X1.5	6	04	19.5			17
Q20111-12-05	M12X1.5	8	05	19.5			17
Q20111-14-04T	M14X1.5	6	04	19.5			17
Q20111-14-05	M14X1.5	8	05	19.5			19
Q20111-16-04T	M16X1.5	6	04	20			19
Q20111-16-05T	M16X1.5	8	05	20			19
Q20111-18-06T	M18X1.5	10	06	20.5			22
Q20111-18-08	M18X1.5	13	08	22			24
Q20111-22-08T	M22X1.5	13	08	22.8			27
Q20111-24-10	M24X1.5	16	10	25.5			30
Q20111-27-10T	M27X1.5	16	10	23.5			32
Q20111-30-12T	M30X1.5	19	12	24.5			36
Q20111-39-16T	M39X2	25	16	29.5			46
Q20111-45-20T	M45X2	32	20	31.5			55
Q20111-52-24T	M52X2	38	24	33			60

注：1、表中代号用于编织软管。2、如需用于缠绕软管代号改为Q20112-XX-XX。 Note:1.For use with braided hoses. 2.If use with spiral hoses,hose fitting series number is Q 20112-XX-XX.

Q20141

45°弯 公制内螺纹球面
45° Metric Female Multiseal

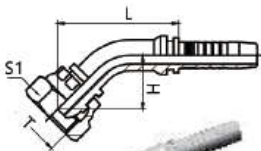

Q20141-T

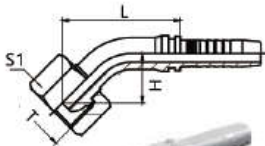

代号 PART NO.	螺纹T THREAD T	软管 HOSE BORE		尺寸 DIMENSIONS			
		公称内径DN	标号 DASH	L	H		S1
Q20141-12-04	M12X1.5	6	04	39.5	16.5		17
Q20141-14-04T	M14X1.5	6	04	43	18.3		17
Q20141-14-05	M14X1.5	8	05	45.5	22.2		19
Q20141-16-04T	M16X1.5	6	04	42.5	21.4		19
Q20141-16-05T	M16X1.5	8	05	44.5	19.5		19
Q20141-16-06	M16X1.5	10	06	50	24		22
Q20141-18-06T	M18X1.5	10	06	50	24		22
Q20141-18-08	M18X1.5	13	08	58.5	28.8		24
Q20141-22-08T	M22X1.5	13	08	60	27.2		27
Q20141-24-10	M24X1.5	16	10	67	27		30
Q20141-27-10T	M27X1.5	16	10	69	29.6		32
Q20141-30-12T	M30X1.5	19	12	76.5	33.7		36
Q20141-39-16T	M39X2	25	16	86	33.6		46
Q20141-45-20T	M45X2	32	20	99	38.4		55
Q20141-52-24T	M52X2	38	24	114	44.6		60

注：1、表中代号用于编织软管。2、如需用于缠绕软管代号改为Q20142-XX-XX。 Note:1.For use with braided hoses. 2.If use with spiral hoses,hose fitting series number is Q20142-XX-XX.

Q20191

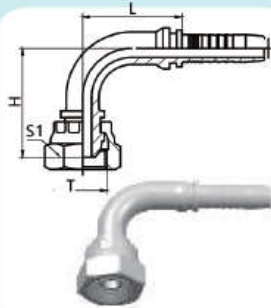

Q20191-T

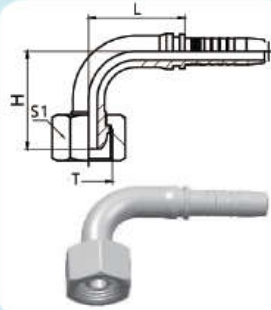

90°弯公制内螺纹球面
90°Metric Female Multiseal

代号 PART NO.	螺纹T THREAD T	软管 HOSE BORE		尺寸 DIMENSIONS		
		公称内径DN	标号 DASH	L	H	S1
Q20191-12-04	M12X1.5	6	04	30	32	17
Q20191-14-04T	M14X1.5	6	04	32	35.5	17
Q20191-14-05	M14X1.5	8	05	33	40.5	19
Q20191-16-04T	M16X1.5	6	04	32	34.5	19
Q20191-16-05T	M16X1.5	8	05	33	41	19
Q20191-16-06	M16X1.5	10	06	36.5	43	22
Q20191-18-06T	M18X1.5	10	06	36.5	44.5	22
Q20191-18-08	M18X1.5	13	08	43.5	50	24
Q20191-22-08T	M22X1.5	13	08	43.5	52	27
Q20191-24-10	M24X1.5	16	10	55	56.5	30
Q20191-27-10T	M27X1.5	16	10	55	54	32
Q20191-30-12T	M30X1.5	19	12	64	67	36
Q20191-39-16T	M39X2	25	16	74	72	46
Q20191-45-20T	M45X2	32	20	91.5	85	55
Q20191-52-24T	M52X2	38	24	109	100	60

注：1、表中代号用于编织软管。2、如需用于缠绕软管代号改为Q20192-XX-XX。 Note:1.For use with braided hoses. 2.If use with spiral hoses,hose fitting series number is Q20192-XX-XX.

Q20211

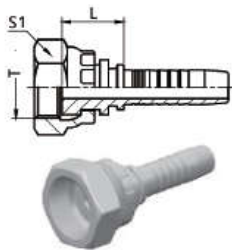

Q20211-T

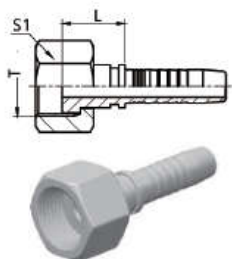

公制内螺纹平面
Metric Female Flat Seat
REF.GB/T 9065.3

代号 PART NO.	螺纹T THREAD T	软管 HOSE BORE		尺寸 DIMENSIONS		
		公称内径DN	标号 DASH	L		S1
Q20211-14-04T	M14X1.5	6	04	15.5		17
Q20211-14-05	M14X1.5	8	05	15.5		19
Q20211-16-05T	M16X1.5	8	05	16.5		19
Q20211-16-06	M16X1.5	10	06	16.5		22
Q20211-18-06T	M18X1.5	10	06	17.5		22
Q20211-22-08T	M22X1.5	13	08	18.5		27
Q20211-27-10T	M27X1.5	16	10	22		32
Q20211-30-12T	M30X1.5	19	12	21		36
Q20211-36-12T	M36X2	19	12	21		41
Q20211-39-16T	M39X2	25	16	23.5		46
Q20211-45-20T	M45X2	32	20	24.5		55
Q20211-52-24T	M52X2	38	24	25		60
Q20211-60-28T	M60X2	45	28	26		70
Q20211-64-32T	M64X2	51	32	27		75

注：1、表中代号用于编织软管。2、如需用于缠绕软管代号改为Q20212-XX-XX。 Note:1.For use with braided hoses. 2.If use with spiral hoses,hose fitting series number is Q20212-XX-XX.

Q20241

45°弯公制内螺纹平面
45°Metric Female Flat Seat
REF. GB/T 9065.3



Q20241-T

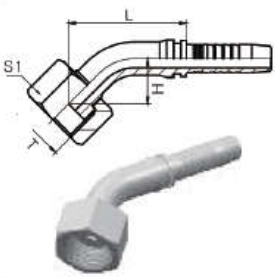

代号 PART NO.	螺纹 T THREAD T	软管 HOSE BORE		尺寸 DIMENSIONS		
		公称内径 DN	标号 DASH	L	H	S1
Q20241-14-04T	M14X1.5	6	04	37	13.5	17
Q20241-14-05	M14X1.5	8	05	41	17.5	19
Q20241-16-05T	M16X1.5	8	05	42	18.5	19
Q20241-16-06	M16X1.5	10	06	45	19	22
Q20241-18-06T	M18X1.5	10	06	46	20	22
Q20241-22-08T	M22X1.5	13	08	53	21.5	27
Q20241-27-10T	M27X1.5	16	10	65	25.5	32
Q20241-30-12T	M30X1.5	19	12	70	27.5	36
Q20241-39-16T	M39X2	25	16	84	29.7	46
Q20241-45-20T	M45X2	32	20	94.5	34	55
Q20241-52-24T	M52X2	38	24	110	41	60
Q20241-60-28T	M60X2	45	28	118.5	43.6	70
Q20241-64-32T	M64X2	51	32	128	45.5	75

注：1、表中代号用于编织软管。2、如需用于缠绕软管代号改为Q20242-XX-XX。 Note:1.For use with braided hoses. 2.If use with spiral hoses,hose fitting series number is Q20242-XX-XX.

Q20291

90°弯公制内螺纹平面
90° Metric Female Flat Seat
REF.GB/T 9065.3

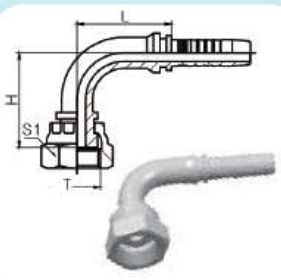

Q20291-T



代号 PART NO.	螺纹 T THREAD T	软管 HOSE BORE		尺寸 DIMENSIONS		
		公称内径 DN	标号 DASH	L	H	S1
Q20291-14-04T	M14X1.5	6	04	32	28.5	17
Q20291-14-05	M14X1.5	8	05	33	33.5	19
Q20291-16-05T	M16X1.5	8	05	32.5	35	19
Q20291-16-06	M16X1.5	10	06	36.5	37	22
Q20291-18-06T	M18X1.5	10	06	36.5	39	22
Q20291-22-08T	M22X1.5	13	08	43.5	43.5	27
Q20291-27-10T	M27X1.5	16	10	55	52	32
Q20291-30-12T	M30X1.5	19	12	63	58	36
Q20291-39-16T	M39X2	25	16	74	68.5	46
Q20291-45-20T	M45X2	32	20	91.5	78.5	55
Q20291-52-24T	M52X2	38	24	109	92	60
Q20291-64-32T	M64X2	51	32	129	113.3	75

注：1、表中代号用于编织软管。2、如需用于缠绕软管代号改为Q20292-XX-XX。 Note:1.For use with braided hoses. 2.If use with spiral hoses,hose fitting series number is Q20292-XX-XX.

Q20711

国标公制内螺纹74°内锥面
GB Metric Female 74° Cone Seat
REF.GB/T 9065.1

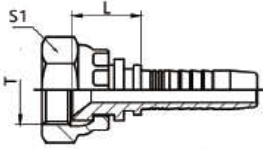

Q20711-T

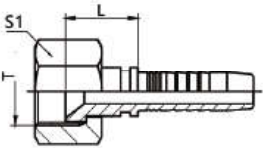

代号 PART NO.	螺纹 T THREAD T	软管 HOSE BORE		尺寸 DIMENSIONS		
		公称内径 DN	标号 DASH	L		S1
Q20711-12-04	M12X1.5	6	04	14.5		17
Q20711-14-04T	M14X1.5	6	04	15.5		17
Q20711-14-05	M14X1.5	8	05	15.5		19
Q20711-14-06	M14X1.5	10	06	15.5		19
Q20711-16-04T	M16X1.5	6	04	16.5		19
Q20711-16-05T	M16X1.5	8	05	16.5		19
Q20711-16-06	M16X1.5	10	06	16.5		22
Q20711-18-05T	M18X1.5	8	05	18.5		22
Q20711-18-06T	M18X1.5	10	06	17.5		22
Q20711-20-06T	M20X1.5	10	06	16		24
Q20711-22-08T	M22X1.5	13	08	18.5		27
Q20711-27-08T	M27X1.5	13	08	20.5		32
QS20711-27-10T	M27X1.5	16	10	21.5		32
QS20711-30-10T	M30X1.5	16	10	21.5		36
QS20711-30-12T	M30X1.5	19	12	21.5		36
QS20711-33-12T	M33X2	19	12	22		41
QS20711-36-12T	M36X2	19	12	21		41
QS20711-36-14T	M36X2	22	14	21		41
QS20711-36-16T	M36X2	25	16	22		41
QS20711-39-16T	M39X2	25	16	23.5		46
QS20711-42-16T	M42X2	25	16	23.5		50
QS20711-45-20T	M45X2	32	20	25		55
QS20711-52-24T	M52X2	38	24	25		60

注：1、表中代号用于编织软管。2、如需用于缠绕软管代号改为Q20712-XX-XX。 Note:1.For use with braided hoses. 2.If use with spiral hoses,hose fitting series number is Q20712-XX-XX.

Q20741

45°国标公制内螺纹74°内锥面
45°GB Metric Female 74°Cone Seat
REF.GB/T 9065.1

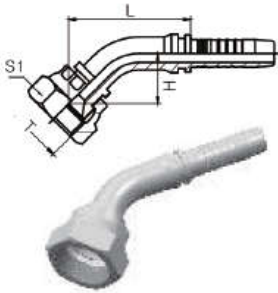

Q20741-T

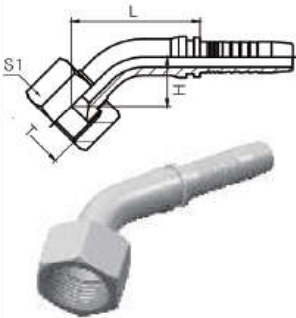

代号 PART NO.	螺纹T THREAD T	软管 HOSE BORE		尺寸 DIMENSIONS		
		公称内径DN	标号 DASH	L	H	S1
Q20741-12-04	M12X1.5	6	04	38	15	17
Q20741-14-04T	M14X1.5	6	04	39	16	17
Q20741-14-05	M14X1.5	8	05	43.5	19.5	19
Q20741-14-06	M14X1.5	10	06	46	20	19
Q20741-16-04T	M16X1.5	6	04	39	15.5	19
Q20741-16-05T	M16X1.5	8	05	42.5	19	19
Q20741-16-06	M16X1.5	10	06	46.5	20.5	22
Q20741-18-05T	M18X1.5	8	05	44.5	21	22
Q20741-18-06T	M18X1.5	10	06	47	23	22
Q20741-22-08T	M22X1.5	13	08	56.2	23.7	27
Q20741-27-08T	M27X1.5	13	08	55	22.5	32
Q20741-27-10T	M27X1.5	16	10	63.5	24	32
Q20741-30-10T	M30X1.5	16	10	67	27	36
Q20741-30-12T	M30X1.5	19	12	72.8	30.2	36
Q20741-33-12T	M33X2	19	12	72	29.5	41
Q20741-36-12T	M36X2	19	12	69.5	26.5	41
Q20741-36-14T	M36X2	22	14	74	28.4	41
Q20741-36-16T	M36X2	25	16	81	28	41
Q20741-39-16T	M39X2	25	16	82	29.4	46
Q20741-45-20T	M45X2	32	20	94.5	33.8	55
Q20741-52-24T	M52X2	38	24	108	39	60

注：1、表中代号用于编织软管。2、如需用于缠绕软管代号改为Q20742-XX-XX。 Note:1.For use with braided hoses. 2.If use with spiral hoses,hose fitting series number is Q20742-XX-XX.

90°国标公制内螺纹74°内锥面
90°GB Metric Female 74° Cone Seat
REF.GB/T 9065.1

Q20791

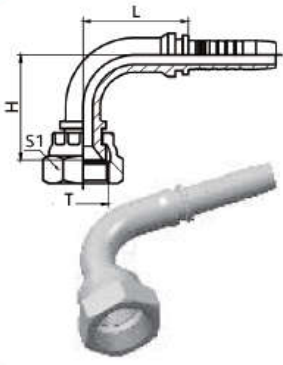

Q20791-T

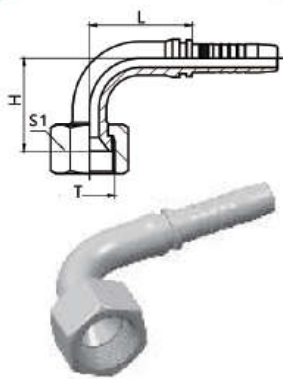

代号 PART NO.	螺纹T THREAD T	软管 HOSE BORE		尺寸 DIMENSIONS		
		公称内径DN	标号 DASH	L	H	S1
Q20791-12-04	M12X1.5	6	04	32	30	17
Q20791-14-04T	M14X1.5	6	04	30	30	17
Q20791-14-05	M14X1.5	8	05	33	37	19
Q20791-14-06	M14X1.5	10	06	36.5	38.5	19
Q20791-16-04T	M16X1.5	6	04	32	32.5	19
Q20791-16-05T	M16X1.5	8	05	33	36	19
Q20791-16-06	M16X1.5	10	06	36.5	39.5	22
Q20791-18-05T	M18X1.5	8	05	33	38.5	22
Q20791-18-06T	M18X1.5	10	06	36.5	40.5	22
Q20791-22-08T	M22X1.5	13	08	43.5	46.5	27
Q20791-27-08T	M27X1.5	13	08	43.5	48.5	32
Q20791-27-10T	M27X1.5	16	10	55	53	32
Q20791-30-10T	M30X1.5	16	10	55	54	36
Q20791-30-12T	M30X1.5	19	12	64	62	36
Q20791-33-12T	M33X2	19	12	64	61	41
Q20791-36-12T	M36X2	19	12	64	57	41
Q20791-36-14T	M36X2	22	14	68.5	63	41
Q20791-36-16T	M36X2	25	16	74	64	41
Q20791-39-16T	M39X2	25	16	74	66	46
Q20791-45-20T	M45X2	32	20	91.5	78.5	55
Q20791-52-24T	M52X2	38	24	109	92	60

注：1、表中代号用于编织软管。2、如需用于缠绕软管代号改为Q20792-XX-XX。 Note:1.For use with braided hoses. 2.If use with spiral hoses,hose fitting series number is Q20792-XX-XX.

Q50011

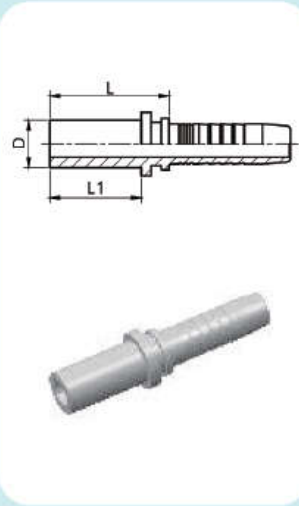

卡套式直管
Metric Standpipe Straight

代号 PART NO.	管子外径 TUBE O.D	软管 HOSE BORE		尺寸 DIMENSIONS			备注 NOTE
		公称内径DN	标号 DASH	L	D	L1	
Q50011-06L-04	6	6	04	29.5	6	22	轻系列 (L)
Q50011-10L-05	10	8	05	31	10	23	
Q50011-10L-06	10	10	06	33.5	10	23	
Q50011-12L-06	12	10	06	32	12	25	
Q50011-12L-08	12	13	08	32.5	12	25	
Q50011-15-08	15	13	08	35.5	15	25	
Q50011-18-10	18	16	10	35	18	26	
Q50011-22-10	22	16	10	38	22	28	
Q50011-22-12	22	19	12	38	22	28	
Q50011-22-16	22	25	16	39	22	28	
Q50011-28-16	28	25	16	41	28	30	
Q50011-35-20	35	32	20	56	35	36	
Q50011-42-24	42	38	24	62	42	40	
Q50011-08S-04	8	6	04	31	8	24	重系列 (S)
Q50011-08S-05	8	8	05	31	8	24	
Q50011-08S-06	8	10	06	31	8	24	
Q50011-10S-04	10	6	04	35	10	23	
Q50011-12S-04	12	6	04	33	12	25	
Q50011-12S-05	12	8	05	33	12	25	
Q50011-14-05	14	8	05	39.5	14	29	
Q50011-14-06	14	10	06	39.5	14	29	
Q50011-14-08	14	13	08	40	14	29	
Q50011-16-08	16	13	08	41	16	30	
Q50011-16-10	16	16	10	42	16	30	
Q50011-20-10	20	16	10	52.5	20	36	
Q50011-20-12	20	19	12	52.5	20	36	
Q50011-25-12	25	19	12	56	25	40	
Q50011-25-16	25	25	16	57	25	40	
Q50011-30-16	30	25	16	63	30	44	
Q50011-30-20	30	32	20	64	30	44	
Q50011-38-16	38	25	16	69	38	50	
Q50011-38-20	38	32	20	70	38	50	

注：1、表中代号用于编织软管。2、如需用于缠绕软管代号改为Q50012-XX-XX。 Note:1.For use with braided hoses. 2.If use with spiral hoses,hose fitting series number is Q50012-XX-XX.

Q50041

45°弯公制卡套式直管
45°Metric Standpipe Straight

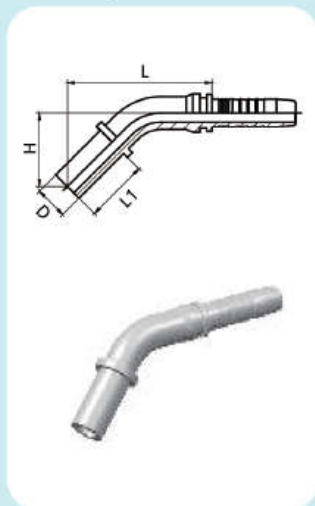

代号 PART NO.	管子外径 TUBE O.D	软管 HOSE BORE		尺寸 DIMENSIONS				备注 NOTE
		公称内径DN	标号 DASH	L	H	D	L1	
Q50041-06L-04	6	6	04	52	30	6	22	轻系列 (L)
Q50041-10L-05	10	8	05	54	30.5	10	23	
Q50041-10L-06	10	10	06	56	31	10	23	
Q50041-12L-06	12	10	06	58.5	34	12	25	
Q50041-12L-08	12	13	08	73	37	12	25	
Q50041-15-08	15	13	08	71	35.5	15	25	
Q50041-18-10	18	16	10	85	39.5	18	26	
Q50041-22-10	22	16	10	87	42	22	28	
Q50041-22-12	22	19	12	93.5	45.5	22	28	
Q50041-22-16	22	25	16	101	46.5	22	28	
Q50041-28-16	28	25	16	104	49.5	28	30	
Q50041-35-20	35	32	20	119	57.5	35	36	
Q50041-08S-04	8	6	04	54	30	8	24	
Q50041-08S-05	8	8	05	56	32	8	24	
Q50041-08S-06	8	10	06	58	33	8	24	
Q50041-10S-04	10	6	04	54	31	10	23	
Q50041-12S-04	12	6	04	57	35	12	25	
Q50041-12S-05	12	8	05	59	35.5	12	25	
Q50041-14-05	14	8	05	61	37	14	29	
Q50041-14-06	14	10	06	62	37.5	14	29	
Q50041-14-08	14	13	08	74	38.5	14	29	
Q50041-16-08	16	13	08	77	41.5	16	30	
Q50041-16-10	16	16	10	88	43	16	30	
Q50041-20-10	20	16	10	93	48	20	36	
Q50041-20-12	20	19	12	101	52.5	20	36	
Q50041-25-12	25	19	12	102	54	25	40	
Q50041-25-16	25	25	16	110	55	25	40	
Q50041-30-16	30	25	16	114	59.5	30	44	
Q50041-30-20	30	32	20	125	63.5	30	44	
Q50041-38-16	38	25	16	119	63.5	38	50	
Q50041-38-20	38	32	20	129	68	38	50	

注：1、表中代号用于编织软管。2、如需用于缠绕软管代号改为Q50042-XX-XX。 Note:1.For use with braided hoses. 2.If use with spiral hoses,hose fitting series number is Q50042-XX-XX.

Q50091

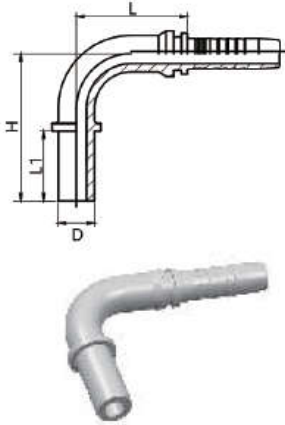
90°弯公制卡套式直管
90°Metric Standpipe Straight

代号 PART NO.	管子外径 TUBE O.D	软管 HOSE BORE		尺寸 DIMENSIONS				备注 NOTE
		公称内径DN	标号 DASH	L	H	D	L1	
Q50091-06L-04	6	6	04	31	44	6	22	轻系列 (L)
Q50091-10L-05	10	8	05	33	53	10	23	
Q50091-10L-06	10	10	06	36.5	55	10	23	
Q50091-12L-06	12	10	06	36.5	60	12	25	
Q50091-12L-08	12	13	08	43.5	67	12	25	
Q50091-15-08	15	13	08	43.5	69	15	25	
Q50091-18-10	18	16	10	55	73	18	26	
Q50091-22-10	22	16	10	55	75	22	28	
Q50091-22-12	22	19	12	64	86	22	28	
Q50091-22-16	22	25	16	74	91.5	22	28	
Q50091-28-16	28	25	16	74	93.5	28	30	
Q50091-35-20	35	32	20	91.5	112.5	35	36	
Q50091-08S-04	8	6	04	30	48	8	24	
Q50091-08S-05	8	8	05	33	55	8	24	
Q50091-08S-06	8	10	06	36.5	58	8	24	
Q50091-10S-04	10	6	04	32	50	10	23	
Q50091-12S-04	12	6	04	32	50	12	23	
Q50091-12S-05	12	8	05	33	60	12	23	
Q50091-14-06	14	10	06	36.5	63	14	29	
Q50091-14-08	14	13	08	43.5	69	14	29	
Q50091-16-08	16	13	08	43.5	70	16	30	
Q50091-16-10	16	16	10	55	77.5	16	30	
Q50091-20-10	20	16	10	55	83.5	20	36	
Q50091-20-12	20	19	12	64	95.5	20	36	
Q50091-25-12	25	19	12	64	99.5	25	40	
Q50091-25-16	25	25	16	74	103.5	25	40	
Q50091-30-16	30	25	16	74	109.5	30	40	
Q50091-30-20	30	32	20	91.5	120.5	30	44	
Q50091-38-16	38	25	16	74	115.5	38	50	
Q50091-38-20	38	32	20	91.5	126.5	38	50	

注：1、表中代号用于编织软管。2、如需用于缠绕软管代号改为Q50092-XX-XX。 Note:1.For use with braided hoses. 2.If use with spiral hoses,hose fitting series number is Q50092-XX-XX.

Q12611

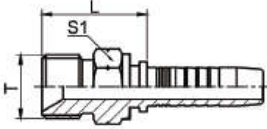
英管外螺纹60°内锥面
BSP Metric 60° Cone Seat -ISO 12151-6

代号 PART NO.	螺纹T THREAD T	软管 HOSE BORE		尺寸 DIMENSIONS		
		公称内径DN	标号 DASH	L		S1
Q12611-04-04	G1/4"X19	6	04	24.5		14
Q12611-06-05	G3/8"X19	8	05	27.5		17
Q12611-06-06	G3/8"X19	10	06	27.5		17
Q12611-06-08	G3/8"X19	13	08	26.5		19
Q12611-08-06	G1/2"X14	10	06	30.5		22
Q12611-08-08	G1/2"X14	13	08	31		22
Q12611-10-08	G5/8"X14	13	08	32.5		24
Q12611-10-10	G5/8"X14	16	10	33.5		24
Q12611-12-08	G3/4"X14	13	08	35.5		27
Q12611-12-10	G3/4"X14	16	10	36.5		27
Q12611-12-12	G3/4"X14	19	12	36.5		27
Q12611-16-12	G1"X11	19	12	39.5		36
Q12611-16-16	G1"X11	25	16	41.5		36
Q12611-20-16	G1.1/4"X11	25	16	43.5		46
Q12611-20-20	G1.1/4"X11	32	20	44.5		46
Q12611-24-20	G1.1/2"X11	32	20	46		50
Q12611-24-24	G1.1/2"X11	38	24	46		50
Q12611-32-32	G2"X11	51	32	53.5		65

注：1、表中代号用于编织软管。2、如需用于缠绕软管代号改为Q12612-XX-XX。 Note: 1.For use with braided hoses. 2.If use with spiral hoses,hose fitting series number is Q12612-XX-XX.

Q12611A

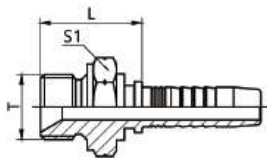
英管外螺纹60°内锥面或六角端面组合垫密封的双用接头
BSP Male Double Use For 60° Cone Seat Or Bonded Seal ISO 12151-6

代号 PART NO.	螺纹T THREAD T	软管 HOSE BORE		尺寸 DIMENSIONS		
		公称内径DN	标号 DASH	L		S1
Q12611A-04-04	G1/4"X19	6	04	25.5		19
Q12611A-06-05	G3/8"X19	8	05	27.5		22
Q12611A-06-06	G3/8"X19	10	06	26		22
Q12611A-06-08	G3/8"X19	13	08	28		22
Q12611A-08-06	G1/2"X14	10	06	32		27
Q12611A-08-08	G1/2"X14	13	08	33		27
Q12611A-08-10	G1/2"X14	16	10	34		27
Q12611A-10-08	G5/8"X14	13	08	36		30
Q12611A-10-10	G5/8"X14	16	10	37		30
Q12611A-12-08	G3/4"X14	13	08	35		32
Q12611A-12-10	G3/4"X14	16	10	36		32
Q12611A-12-12	G3/4"X14	19	12	37		32
Q12611A-16-12	G1"X11	19	12	39		41
Q12611A-16-16	G1"X11	25	16	42		41
Q12611A-20-16	G1.1/4"X11	25	16	45		50
Q12611A-20-20	G1.1/4"X11	32	20	45		50
Q12611A-24-20	G1.1/2"X11	32	20	46		55
Q12611A-24-24	G1.1/2"X11	38	24	49		55
Q12611A-32-32	G2"X11	51	32	54.5		70

注：1、表中代号用于编织软管。2、如需用于缠绕软管代号改为Q12612A-XX-XX。 Note: 1.For use with braided hoses. 2.If use with spiral hoses,hose fitting series number is Q12612A-XX-XX.

Q22611

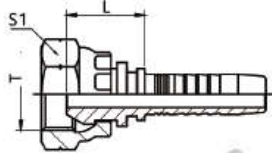

Q22611-T

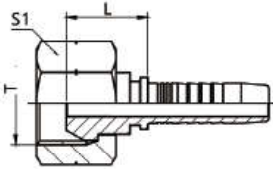

英管内螺纹60°外锥面
BSP Female 60° Cone ISO 12151-6

代号 PART NO.	螺纹T THREAD T	软管 HOSE BORE		尺寸 DIMENSIONS		
		公称内径DN	标号 DASH	L		S1
Q22611-02-04	G1/8 " X28	6	04	16		14
Q22611-04-04	G1/4 " X19	6	04	19		19
Q22611-04-05	G1/4 " X19	8	05	19		19
Q22611-04-06	G1/4 " X19	10	06	19		19
Q22611-06-04T	G3/8 " X19	6	04	18		22
Q22611-06-05T	G3/8 " X19	8	05	19		22
Q22611-06-06	G3/8 " X19	10	06	19.5		22
Q22611-06-08	G3/8 " X19	13	08	20		22
Q22611-08-06T	G1/2 " X14	10	06	20.5		27
Q22611-08-08	G1/2 " X14	13	08	21.5		27
Q22611-10-08T	G5/8 " X14	13	08	22.5		30
Q22611-10-10	G5/8 " X14	16	10	23		30
Q22611-12-10T	G3/4 " X14	16	10	23		32
Q22611-12-12	G3/4 " X14	19	12	24		32
Q22611-16-12T	G1 " X11	19	12	24		41
Q22611-16-16	G1 " X11	25	16	26		41
Q22611-20-16T	G1.1/4 " X11	25	16	27.5		50
Q22611-20-20	G1.1/4 " X11	32	20	30.5		50
Q22611-24-20T	G1.1/2 " X11	32	20	32		55
QS22611-24-24	G1.1/2 " X11	38	24	31.5		55
QS22611-32-24T	G2 " X11	38	24	33.5		70
QS22611-32-32	G2 " X11	51	32	34		70

注：1、表中代号用于编织软管。2、如需用于缠绕软管代号改为Q22612-XX-XX。 Note: 1. For use with braided hoses. 2. If use with spiral hoses, hose fitting series number is Q22612-XX-XX.

Q22641

45°英管内螺纹60°外锥面

45° BSP Female 60° Cone ISO 12151-6



Q22641-T

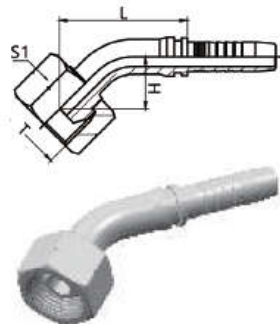

代号 PART NO.	螺纹T THREAD T	软管 HOSE BORE		尺寸 DIMENSIONS		
		公称内径DN	标号 DASH	L	H	S1
Q22641-02-04	G1/8"X28	6	04	38.8	15	14
Q22641-04-04	G1/4"X19	6	04	38.8	15	19
Q22641-04-05	G1/4"X19	8	05	41.7	18	19
Q22641-04-06	G1/4"X19	10	06	45	19	19
Q22641-06-04T	G3/8"X19	6	04	39.8	16	22
Q22641-06-05T	G3/8"X19	8	05	41.7	18	22
Q22641-06-06	G3/8"X19	10	06	44	18	22
Q22641-06-08	G3/8"X19	13	08	54.3	23	22
Q22641-08-06T	G1/2"X14	10	06	44	18	27
Q22641-08-08	G1/2"X14	13	08	51.3	20	27
Q22641-10-08T	G5/8"X14	13	08	54.3	23	30
Q22641-10-10	G5/8"X14	16	10	64.2	25	30
Q22641-12-10T	G3/4"X14	16	10	67.2	28	32
Q22641-12-12	G3/4"X14	19	12	71.7	29	32
Q22641-16-12T	G1"X11	19	12	74.7	32	41
Q22641-16-16	G1"X11	25	16	84.4	35	41
Q22641-20-16T	G1.1/4"X11	25	16	88.4	39	50
Q22641-20-20	G1.1/4"X11	32	20	100.8	40	50
Q22641-24-20T	G1.1/2"X11	32	20	114.8	54	55
Q22641-24-24	G1.1/2"X11	38	24	121.1	50	55
Q22641-32-24T	G2"X11	38	24	130.1	59	70
Q22641-32-32	G2"X11	51	32	155	70	70

注：1、表中代号用于编织软管。2、如需用于缠绕软管代号改为Q22642-XX-XX。 Note:1.For use with braided hoses. 2.If use with spiral hoses,hose fitting series number is Q22642-XX-XX.

Q22691

90°英管内螺纹60°外锥面
BSP Female 60° Cone ISO 12151-6

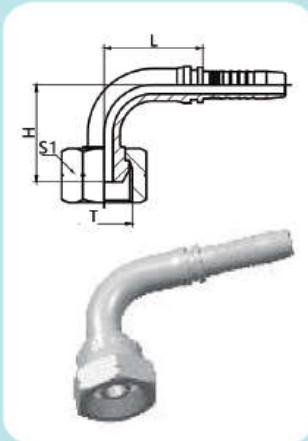

Q22691-T

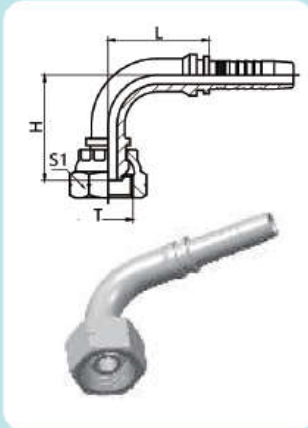

代号 PART NO.	螺纹T THREAD T	软管 HOSE BORE		尺寸 DIMENSIONS		
		公称内径DN	标号 DASH	L	H	S1
Q22691-02-04	G1/8 " X28	6	04	32	27	14
Q22691-04-04	G1/4 " X19	6	04	32	28	19
Q22691-04-05	G1/4 " X19	8	05	32.5	31.5	19
Q22691-04-06	G1/4 " X19	10	06	36.5	34	19
Q22691-06-04T	G3/8 " X19	6	04	32	31	22
Q22691-06-05T	G3/8 " X19	8	05	32.5	34	22
Q22691-06-06	G3/8 " X19	10	06	36.5	34	22
Q22691-06-08	G3/8 " X19	13	08	44.5	42	22
Q22691-08-06T	G1/2 " X14	10	06	36.5	35	27
Q22691-08-08	G1/2 " X14	13	08	44.5	41	27
Q22691-10-08T	G5/8 " X14	13	08	44.5	45	30
Q22691-10-10	G5/8 " X14	16	10	55	51	30
Q22691-12-10T	G3/4 " X14	16	10	55	56	32
Q22691-12-12	G3/4 " X14	19	12	62	58	32
Q22691-16-12T	G1 " X11	19	12	62	62	41
Q22691-16-16	G1 " X11	25	16	74	70	41
Q22691-20-16T	G1.1/4 " X11	25	16	74	76	50
Q22691-20-20	G1.1/4 " X11	32	20	91.5	85	50
Q22691-24-20T	G1.1/2 " X11	32	20	91.5	92	55
Q22691-24-24	G1.1/2 " X11	38	24	108	100	55
Q22691-32-24T	G2 " X11	38	24	108	110	70
Q22691-32-32	G2 " X11	51	32	133.8	140	70

注：1、表中代号用于编织软管。2、如需用于缠绕软管代号改为Q22692-XX-XX。 Note:1.For use with braided hoses. 2.If use with spiral hoses,hose fitting series number is Q22692-XX-XX.

Q22611-OR

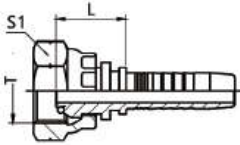
英管内螺纹60°外锥面带O型圈
BSP Female 60°O-Ring Cone ISO 12151-6

Q22611-ORT

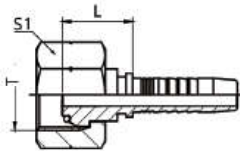

代号 PART NO.	螺纹T THREAD T	软管 HOSE BORE		尺寸 DIMENSIONS			
		公称内径DN	标号 DASH	L			S1
Q22611-02-04OR	G1/8 " X28	6	04	15			14
Q22611-04-04OR	G1/4 " X19	6	04	19			19
Q22611-04-05OR	G1/4 " X19	8	05	19			19
Q22611-04-06OR	G1/4 " X19	10	06	19			19
Q22611-06-04ORT	G3/8 " X19	6	04	18			22
Q22611-06-05ORT	G3/8 " X19	8	05	19			22
Q22611-06-06OR	G3/8 " X19	10	06	19.5			22
Q22611-06-08OR	G3/8 " X19	13	08	20			22
Q22611-08-06ORT	G1/2 " X14	10	06	21			27
Q22611-08-08OR	G1/2 " X14	13	08	21.5			27
Q22611-10-08ORT	G5/8 " X14	13	08	21.5			30
Q22611-10-10OR	G5/8 " X14	16	10	23			30
Q22611-12-10ORT	G3/4 " X14	16	10	23			32
Q22611-12-12OR	G3/4 " X14	19	12	24			32
Q22611-16-12ORT	G1 " X11	19	12	25			41
Q22611-16-16OR	G1 " X11	25	16	27			41
Q22611-20-16ORT	G1.1/4 " X11	25	16	28.5			50
Q22611-20-20OR	G1.1/4 " X11	32	20	30.5			50
Q22611-24-20ORT	G1.1/2 " X11	32	20	32			55
Q22611-24-24OR	G1.1/2 " X11	38	24	31.5			55
Q22611-32-24ORT	G2 " X11	38	24	33.5			70
Q22611-32-32OR	G2 " X11	51	32	34			70

注：1、表中代号用于编织软管。2、如需用于缠绕软管代号改为Q22612-XX-XX。 Note:1.For use with braided hoses. 2.If use with spiral hoses,hose fitting series number is Q22612-XX-XX.

Q22641-OR

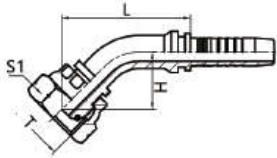

Q22641-ORT

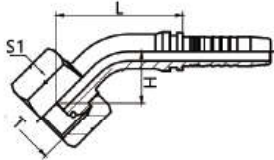

45°英管内螺纹60°外锥面带O型圈
45°BSP Female 60°O-Ring Cone ISO 12151-6

代号 PART NO.	螺纹T THREAD T	软管 HOSE BORE		尺寸 DIMENSIONS		
		公称内径DN	标号 DASH	L	H	S1
Q22641-02-04OR	G1/8 " X28	6	04	38.8	15	14
Q22641-04-04OR	G1/4 " X19	6	04	38.8	15	19
Q22641-04-05OR	G1/4 " X19	8	05	41.7	18	19
Q22641-04-06OR	G1/4 " X19	10	06	45	19	19
Q22641-06-04ORT	G3/8 " X19	6	04	39.8	16	22
Q22641-06-05ORT	G3/8 " X19	8	05	41.7	18	22
Q22641-06-06OR	G3/8 " X19	10	06	44	18	22
Q22641-06-08OR	G3/8 " X19	13	08	54.3	23	22
Q22641-08-06ORT	G1/2 " X14	10	06	44	18	27
Q22641-08-08OR	G1/2 " X14	13	08	51.3	20	27
Q22641-10-08ORT	G5/8 " X14	13	08	54.3	23	30
Q22641-10-10OR	G5/8 " X14	16	10	64.2	25	30
Q22641-12-10ORT	G3/4 " X14	16	10	67.2	28	32
Q22641-12-12OR	G3/4 " X14	19	12	71.7	29	32
Q22641-16-12ORT	G1 " X11	19	12	74.7	32	41
Q22641-16-16OR	G1 " X11	25	16	84.4	35	41
Q22641-20-16ORT	G1.1/4 " X11	25	16	88.4	39	50
Q22641-20-20OR	G1.1/4 " X11	32	20	100.8	40	50
Q22641-24-20ORT	G1.1/2 " X11	32	20	114.8	54	55
Q26411-24-24OR	G1.1/2 " X11	38	24	121.1	50	55
Q22641-32-24ORT	G2 " X11	38	24	130.1	59	70
Q22641-32-32OR	G2 " X11	51	32	155	70	70

注：1、表中代号用于编织软管。2、如需用于缠绕软管代号改为Q22642-XX-XX。 Note:1.For use with braided hoses. 2.If use with spiral hoses,hose fitting series number is Q22642-XX-XX.

Q22691-OR

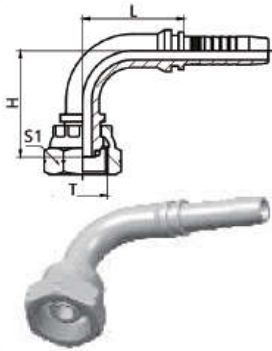

Q22691-ORT

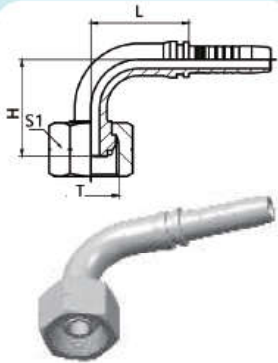

90°英管内螺纹60°外锥面带O型圈
90°BSP Female 60°O-Ring Cone ISO 12151-6

代号 PART NO.	螺纹T THREAD T	软管 HOSE BORE		尺寸 DIMENSIONS		
		公称内径DN	标号 DASH	L	H	S1
Q22691-02-04OR	G1/8 " X28	6	04	32	27	14
Q22691-04-04OR	G1/4 " X19	6	04	32	28	19
Q22691-04-05OR	G1/4 " X19	8	05	32.5	31.5	19
Q22691-04-06OR	G1/4 " X19	10	06	36.5	34	19
Q22691-06-04ORT	G3/8 " X19	6	04	32	31	22
Q22691-06-05ORT	G3/8 " X19	8	05	32.5	34	22
Q22691-06-06OR	G3/8 " X19	10	06	36.5	34	22
Q22691-06-08OR	G3/8 " X19	13	08	44.5	42	22
Q22691-08-06ORT	G1/2 " X14	10	06	36.5	35	27
Q22691-08-08OR	G1/2 " X14	13	08	44.5	41	27
Q22691-10-08ORT	G5/8 " X14	13	08	44.5	45	30
Q22691-10-10OR	G5/8 " X14	16	10	55	51	30
Q22691-12-10ORT	G3/4 " X14	16	10	55	56	32
Q22691-12-12OR	G3/4 " X14	19	12	62	58	32
Q22691-16-12ORT	G1 " X11	19	12	62	62	41
Q22691-16-16OR	G1 " X11	25	16	74	70	41
Q22691-20-16ORT	G1.1/4 " X11	25	16	74	76	50
Q22691-20-20OR	G1.1/4 " X11	32	20	91.5	85	50
Q22691-24-20ORT	G1.1/2 " X11	32	20	91.5	92	55
Q22691-24-24OR	G1.1/2 " X11	38	24	108	100	55
Q22691-32-24ORT	G2 " X11	38	24	108	110	70
Q22691-32-32OR	G2 " X11	51	32	133.8	140	70

注：1、表中代号用于编织软管。2、如需用于缠绕软管代号改为Q22692-XX-XX。 Note:1.For use with braided hoses. 2.If use with spiral hoses,hose fitting series number is Q22692-XX-XX.

Q22611D

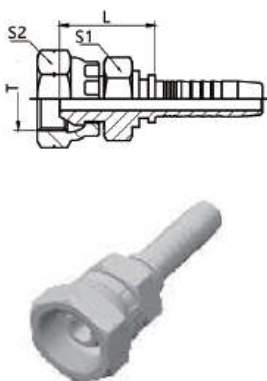

英管内螺纹60°外锥面双六角
BSP Female 60° Cone Double Hexangon ISO 12151-6

代号 PART NO.	螺纹T THREAD T	软管 HOSE BORE		尺寸 DIMENSIONS		
		公称内径DN	标号 DASH	L	S1	S2
Q22611D-04-04	G1/4 " X19	6	04	23.5	19	19
Q22611D-06-06	G3/8 " X19	10	06	26.5	22	22
Q22611D-08-08	G1/2 " X14	13	08	31	27	27
Q22611D-10-08	G5/8 " X14	13	08	32	30	30
Q22611D-12-08	G3/4 " X14	13	08	33	32	32
Q22611D-12-12	G3/4 " X14	19	12	34	32	32
Q22611D-16-16	G1 " X11	25	16	35.5	41	41
Q22611D-20-20	G1.1/4 " X11	32	20	43.5	50	50

注：1、表中代号用于编织软管。2、如需用于缠绕软管代号改为Q22612D-XX-XX。 Note:1.For use with braided hoses. 2.If use with spiral hoses,hose fitting series number is Q22612D-XX-XX.

Q22611D-SM

英管内螺纹60°外锥面双六角
BSP Female 60° Cone Double Hexagon ISO 12151-6

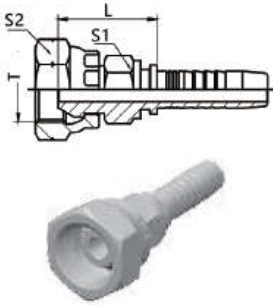

代号 PART NO.	螺纹T THREAD T	软管 HOSE BORE		尺寸 DIMENSIONS			
		公称内径DN	标号 DASH	L	S1	S2	
Q22611D-04-04SM	G1/4 " X19	6	04	23	14	19	
Q22611D-06-06SM	G3/8 " X19	10	06	25	17	22	
Q22611D-08-08SM	G1/2 " X14	13	08	28.5	22	27	
Q22611D-10-08SM	G5/8 " X14	13	08	30	22	30	
Q22611D-12-08SM	G3/4 " X14	13	08	31.5	27	32	
Q22611D-12-12SM	G3/4 " X14	19	12	32.5	27	32	
Q22611D-16-16SM	G1 " X11	25	16	36.3	32	41	
Q22611D-20-20SM	G1.1/4 " X11	32	20	41.5	41	50	

注：1、表中代号用于编织软管。2、如需用于缠绕软管代号改为Q22612D-XX-XXSM。 Note:1.For use with braided hoses. 2.If use with spiral hoses,hose fitting series number is Q22612D-XX-XXSM.

Q22691K

90°英管短身内螺纹60°外锥面
90°BSP Compact Female 60° Cone

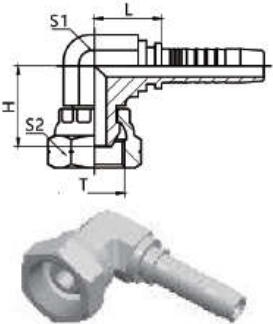

代号 PART NO.	螺纹T THREAD T	软管 HOSE BORE		尺寸 DIMENSIONS			
		公称内径DN	标号 DASH	L	H	S1	S2
Q22691K-04-04	G1/4 " X19	6	04	17.5	22	14	19
Q22691K-06-04	G3/8 " X19	6	04	20	24	16	22
Q22691K-06-05	G3/8 " X19	8	05	20	24	16	22
Q22691K-06-06	G3/8 " X19	10	06	20	24	16	22
Q22691K-08-06	G1/2 " X14	10	06	23	26.5	19	27
Q22691K-08-08	G1/2 " X14	13	08	23.5	28.5	19	27
Q22691K-10-10	G5/8 " X14	16	10	25	29.5	22	30
Q22691K-12-12	G3/4 " X14	19	12	27.5	33	27	32
QS22691K-16-16	G1 " X11	25	16	32.5	38.1	33	41

英锥管外螺纹
BSPT Male

Q13011

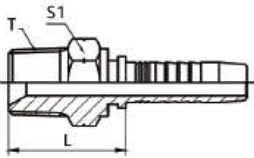

代号 PART NO.	螺纹T THREAD T	软管 HOSE BORE		尺寸 DIMENSIONS		
		公称内径DN	标号 DASH	L		S1
Q13011-02-04	R1/8"X28	6	04	18.5		12
Q13011-04-04	R1/4"X19	6	04	21		17
Q13011-04-05	R1/4"X19	8	05	21		17
Q13011-04-06	R1/4"X19	10	06	21		17
Q13011-06-04	R3/8"X19	6	04	21.1		17
Q13011-06-05	R3/8"X19	8	05	21.1		17
Q13011-06-06	R3/8"X19	10	06	21.1		17
Q13011-06-08	R3/8"X19	13	08	23.6		19
Q13011-08-06	R1/2"X14	10	06	26.3		22
Q13011-08-08	R1/2"X14	13	08	26.8		22
Q13011-08-10	R1/2"X14	16	10	26.8		22
Q13011-08-12	R1/2"X14	19	12	29.8		27
Q13011-12-08	R3/4"X14	13	08	27.5		27
Q13011-12-10	R3/4"X14	16	10	28.5		27
Q13011-12-12	R3/4"X14	19	12	29.3		27
Q13011-12-16	R3/4"X14	25	16	30		32
Q13011-16-12	R1"X11	19	12	35.1		36
Q13011-16-16	R1"X11	25	16	36.1		36
Q13011-20-20	R1.1/4"X11	32	20	36.8		46
Q13011-24-24	R1.1/2"X11	38	24	38.8		50
Q13011-32-24	R2"X11	38	24	42.1		65
Q13011-32-32	R2"X11	51	32	42.1		65

注：1、表中代号用于编织软管。2、如需用于缠绕软管代号改为Q13012-XX-XX。
Note:1.For use with braided hoses. 2.If use with spiral hoses,hose fitting series number is Q13012-XX-XX.

Q22111

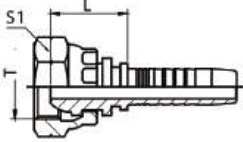
英管内螺纹球面
BSP Female Multiseal

Q22111-T

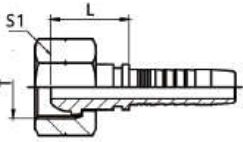

代号 PART NO.	螺纹T THREAD T	软管 HOSE BORE		尺寸 DIMENSIONS		
		公称内径DN	标号 DASH	L		S1
Q22111-02-04	G1/8"X28	6	04	17.5		14
Q22111-04-04	G1/4"X19	6	04	19.5		19
Q22111-06-05T	G3/8"X19	8	05	20		22
Q22111-06-06	G3/8"X19	10	06	20.5		22
Q22111-06-08	G3/8"X19	13	08	21		22
Q22111-08-06T	G1/2"X14	10	06	23		27
Q22111-08-08	G1/2"X14	13	08	24		27
Q22111-08-10	G1/2"X14	16	10	24.5		27
Q22111-10-08T	G5/8"X14	13	08	24		30
Q22111-10-10	G5/8"X14	16	10	25		30
Q22111-10-12	G5/8"X14	19	12	25		30
Q22111-12-10T	G3/4"X14	16	10	26		32
Q22111-12-12	G3/4"X14	19	12	26		32
Q22111-16-12T	G1"X11	19	12	27		41
Q22111-16-16	G1"X11	25	16	28		41
Q22111-20-16T	G1.1/4"X11	25	16	28		50
Q22111-20-20	G1.1/4"X11	32	20	31.5		50
Q22111-24-20T	G1.1/2"X11	32	20	33		55
Q22111-24-24	G1.1/2"X11	38	24	33		55
Q22111-32-24T	G2"X11	38	24	35		70
Q22111-32-32	G2"X11	51	32	35		70

注：1、表中代号用于编织软管。2、如需用于缠绕软管代号改为Q22112-XX-XX。 Note:1.For use with braided hoses. 2.If use with spiral hoses,hose fitting series number is Q22112-XX-XX.

Q22141

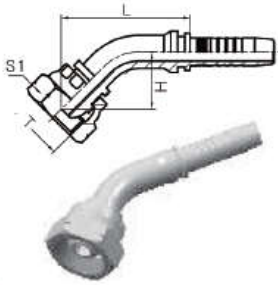
45°英管内螺纹球面
45°BSP Female Multiseal

Q22141-T

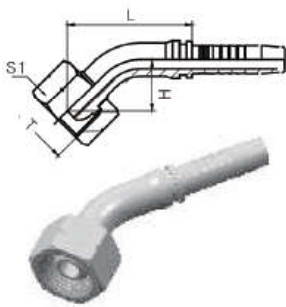

代号 PART NO.	螺纹 T THREAD T	软管 HOSE BORE		尺寸 DIMENSIONS			
		公称内径 DN	标号 DASH	L	H	S1	
Q22141-02-04	G1/8 " X28	6	04	43	21.6	14	
Q22141-04-04	G1/4 " X19	6	04	43	21.6	19	
Q22141-06-05T	G3/8 " X19	8	05	46	22.9	22	
Q22141-06-06	G3/8 " X19	10	06	50	23.9	22	
Q22141-06-08	G3/8 " X19	13	08	58	25.5	22	
Q22141-08-06T	G1/2 " X14	10	06	51	25	27	
Q22141-08-08	G1/2 " X14	13	08	61	26.8	27	
Q22141-08-10	G1/2 " X14	16	10	68	28	27	
Q22141-10-08T	G5/8 " X14	13	08	60	27.5	30	
Q22141-10-10	G5/8 " X14	16	10	68.5	28.8	30	
Q22141-10-12	G5/8 " X14	19	12	74.5	32	30	
Q22141-12-10T	G3/4 " X14	16	10	67	27	32	
Q22141-12-12	G3/4 " X14	19	12	76	33.7	32	
Q22141-16-12T	G1 " X11	19	12	81.6	33	41	
Q22141-16-16	G1 " X11	25	16	88	35.1	41	
Q22141-20-16T	G1.1/4 " X11	25	16	89.5	36.5	50	
Q22141-20-20	G1.1/4 " X11	32	20	101.5	40.8	50	
Q22141-24-20T	G1.1/2 " X11	32	20	104	43	55	
Q22141-24-24	G1.1/2 " X11	38	24	117.5	48.2	55	
Q22141-32-24T	G2 " X11	38	24	120	51	70	
Q22141-32-32	G2 " X11	51	32	138	57	70	

注：1、表中代号用于编织软管。2、如需用于缠绕软管代号改为Q22142-XX-XXRW。 Note:1.For use with braided hoses. 2.If use with spiral hoses,hose fitting series number is Q22142-XX-XXRW.

Q22191

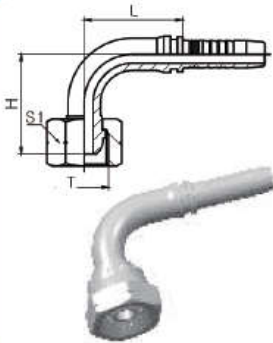
90°英管内螺纹球面
90°BSP Female Multiseal

Q22191-T



代号 PART NO.	螺纹 T THREAD T	软管 HOSE BORE		尺寸 DIMENSIONS		
		公称内径 DN	标号 DASH	L	H	S1
Q22191-02-04	G1/8" X28	6	04	30.5	33	14
Q22191-04-04	G1/4" X19	6	04	30.5	37	19
Q22191-06-05T	G3/8" X19	8	05	33	41.5	22
Q22191-06-06	G3/8" X19	10	06	36.5	43.5	22
Q22191-06-08	G3/8" X19	13	08	43.5	49	22
Q22191-08-06T	G1/2" X14	10	06	36.5	46	27
Q22191-08-08	G1/2" X14	13	08	43.5	51.5	27
Q22191-08-10	G1/2" X14	16	10	55	56	27
Q22191-10-08T	G5/8" X14	13	08	43.5	52	30
Q22191-10-10	G5/8" X14	16	10	55	56.5	30
Q22191-10-12	G5/8" X14	19	12	64	64.5	30
Q22191-12-10T	G3/4" X14	16	10	55	58.5	32
Q22191-12-12	G3/4" X14	19	12	63	66.5	32
Q22191-16-12T	G1" X11	19	12	63	67.5	41
Q22191-16-16	G1" X11	25	16	74	74.5	41
Q22191-20-16T	G1.1/4" X11	25	16	74	76.5	50
Q22191-20-20	G1.1/4" X11	32	20	91.5	89	50
Q22191-24-20T	G1.1/2" X11	32	20	91.5	92.5	55
Q22191-24-24	G1.1/2" X11	38	24	109	106	55
Q22191-32-24T	G2" X11	38	24	109	105	70
Q22191-32-32	G2" X11	51	32	129	125.5	70

注：1、表中代号用于编织软管。2、如需用于缠绕软管代号改为Q22192-XX-XX。 Note:1.For use with braided hoses. 2.If use with spiral hoses,hose fitting series number is Q22192-XX-XX.

Q28611

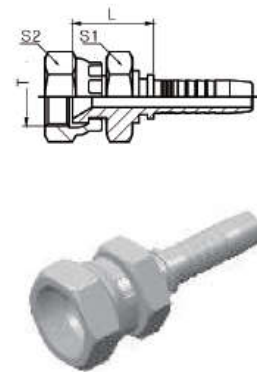
日本公制内螺纹 60°内锥面
JIS Metric Female 60° Cone Seat

代号 PART NO.	螺纹 T THREAD T	软管 HOSE BORE		尺寸 DIMENSIONS		
		公称内径 DN	标号 DASH	L	S1	S2
Q28611-12-04	M12X1.5	6	04	20.5	17	17
Q28611-14-04	M14X1.5	6	04	21	19	19
Q28611-14-06	M14X1.5	10	06	21	19	19
Q28611-16-04	M16X1.5	6	04	24	22	22
Q28611-16-05	M16X1.5	8	05	24	22	22
Q28611-16-06	M16X1.5	10	06	24	22	22
Q28611-18-06	M18X1.5	10	06	25	24	24
Q28611-18-08	M18X1.5	13	08	25.5	24	24
Q28611-20-08	M20X1.5	13	08	28.5	27	27
Q28611-22-08	M22X1.5	13	08	25.5	27	27
Q28611-24-08	M24X1.5	13	08	28	32	32
Q28611-24-10	M24X1.5	16	10	28.5	32	32
Q28611-27-10	M27X1.5	16	10	28.5	32	32
Q28611-30-12	M30X1.5	19	12	28.5	36	36
Q28611-33-12	M33X1.5	19	12	31	41	41
Q28611-33-16	M33X1.5	25	16	32	41	41
Q28611-36-20	M36X1.5	32	20	35.5	46	46

注：1、表中代号用于编织软管。2、如需用于缠绕软管代号改为Q28612-XX-XX。 Note:1.For use with braided hoses. 2.If use with spiral hoses,hose fitting series number is Q28612-XX-XX.

Q28611GM

日本公制内螺纹60°内锥面
JIS Metric Female 60° Cone Seat

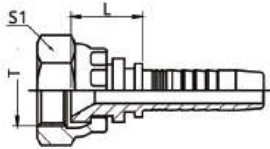

代号 PART NO.	螺纹T THREAD T	软管 HOSE BORE		尺寸 DIMENSIONS			
		公称内径DN	标号 DASH	L			S1
Q28611GM-12-04	M12X1.5	6	04	20			17
Q28611GM-14-04	M14X1.5	6	04	21			19
Q28611GM-14-06	M14X1.5	10	06	21			19
Q28611GM-16-04	M16X1.5	6	04	24			22
Q28611GM-16-05	M16X1.5	8	05	24			22
Q28611GM-16-06	M16X1.5	10	06	24			22
Q28611GM-18-06	M18X1.5	10	06	25			24
Q28611GM-18-08	M18X1.5	13	08	24.5			24
Q28611GM-20-08	M20X1.5	13	08	28.5			27
Q28611GM-22-08	M22X1.5	13	08	25.5			27
Q28611GM-24-08	M24X1.5	13	08	27.5			32
Q28611GM-24-10	M24X1.5	16	10	28.5			32
Q28611GM-27-10	M27X1.5	16	10	28.5			32
Q28611GM-30-12	M30X1.5	19	12	28.5			36
Q28611GM-33-12	M33X1.5	19	12	31			41
Q28611GM-33-16	M33X1.5	25	16	32			41
Q28611GM-36-20	M36X1.5	32	20	35.5			46

注：1、表中代号用于编织软管。2、如需用于缠绕软管代号改为Q28612GM-XX-XX。 Note:1.For use with braided hoses. 2.If use with spiral hoses,hose fitting series number is Q 28612GM-XX-XX.

Q28641

45°日本公制内螺纹60°内锥面
45°JIS Metric Female 60° Cone Seat

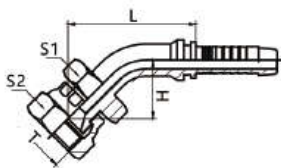

代号 PART NO.	螺纹T THREAD T	软管 HOSE BORE		尺寸 DIMENSIONS			
		公称内径DN	标号 DASH	L	H	S1	S2
Q28641-12-04	M12X1.5	6	04	42.5	19	17	17
Q28641-14-04	M14X1.5	6	04	42.5	19	19	19
Q28641-14-06	M14X1.5	10	06	49	23	19	19
Q28641-16-04	M16X1.5	6	04	45	21.5	22	22
Q28641-16-05	M16X1.5	8	05	49	25.5	22	22
Q28641-16-06	M16X1.5	10	06	51.5	25.5	22	22
Q28641-18-06	M18X1.5	10	06	52	26	24	24
Q28641-18-08	M18X1.5	13	08	61	28.5	24	24
Q28641-22-08	M22X1.5	13	08	61	28.5	27	27
Q28641-24-08	M24X1.5	13	08	62.5	30	32	32
Q28641-24-10	M24X1.5	16	10	71	31	32	32
Q28641-30-12	M30X1.5	19	12	77	34	36	36
Q28641-33-12	M33X1.5	19	12	78.5	36	41	41
Q28641-33-16	M33X1.5	25	16	90	37	41	41
Q28641-36-20	M36X1.5	32	20	104	43.5	46	46

注：1、表中代号用于编织软管。2、如需用于缠绕软管代号改为Q28642-XX-XX。 Note:1.For use with braided hoses. 2.If use with spiral hoses,hose fitting series number is Q28642-XX-XX.

Q28691

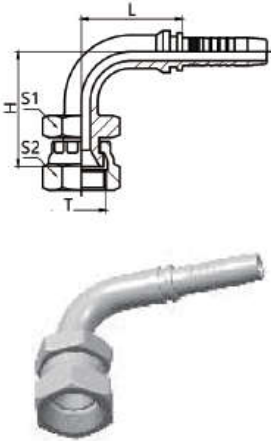
90°日本公制内螺纹60°内锥面
90° JIS Metric Female 60° Cone Seat

代号 PART NO.	螺纹T THREAD T	软管 HOSE BORE		尺寸 DIMENSIONS			
		公称内径DN	标号 DASH	L	H	S1	S2
Q28691-12-04	M12X1.5	6	04	30	29.5	17	17
Q28691-14-04	M14X1.5	6	04	30	30	19	19
Q28691-14-06	M14X1.5	10	06	36.5	28	19	19
Q28691-16-04	M16X1.5	6	04	30	28	22	22
Q28691-16-05	M16X1.5	8	05	36.5	37.5	22	22
Q28691-16-06	M16X1.5	10	06	36.5	39	22	22
Q28691-18-06	M18X1.5	10	06	36.5	41	24	24
Q28691-18-08	M18X1.5	13	08	43.5	46.5	24	24
Q28691-22-08	M22X1.5	13	08	43.5	47	27	27
Q28691-24-08	M24X1.5	13	08	43.5	48.5	32	32
Q28691-24-10	M24X1.5	16	10	55	53	32	32
Q28691-30-12	M30X1.5	19	12	64	62	36	36
Q28691-33-12	M33X1.5	19	12	64	70	41	41
Q28691-33-16	M33X1.5	25	16	74	77	41	41
Q28691-36-20	M36X1.5	32	20	91.5	92	46	46

注：1、表中代号用于编织软管。2、如需用于缠绕软管代号改为Q28692-XX-XX。 Note:1.For use with braided hoses. 2.If use with spiral hoses,hose fitting series number is Q28692-XX-XX.

Q29611

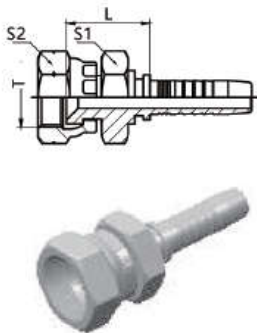
日本英制内螺纹60°内锥面
JIS GAS Female 60° Cone Seat JIS B8363

代号 PART NO.	螺纹T THREAD T	软管 HOSE BORE		尺寸 DIMENSIONS			
		公称内径DN	标号 DASH	L		S1	S2
Q29611-04-04	G1/4 " X19	6	04	21		19	19
Q29611-04-05	G1/4 " X19	8	05	21		19	19
Q29611-06-04	G3/8 " X19	6	04	23.5		22	22
Q29611-06-06	G3/8 " X19	10	06	23		22	22
Q29611-08-06	G1/2 " X14	10	06	26		27	27
Q29611-08-08	G1/2 " X14	13	08	26.5		27	27
Q29611-10-10	G5/8 " X14	16	10	31		30	30
Q29611-12-10	G3/4 " X14	16	10	31.5		32	32
Q29611-12-12	G3/4 " X14	19	12	31.5		32	32
Q29611-16-16	G1 " X11	25	16	32		41	41

注：1、表中代号用于编织软管。2、如需用于缠绕软管代号改为Q29612-XX-XX。 Note:1.For use with braided hoses. 2.If use with spiral hoses,hose fitting series number is Q29612-XX-XX.

Q29641

45°日本英制内螺纹60°内锥面
45° JIS GAS Female 60°Cone Seat JIS B8363

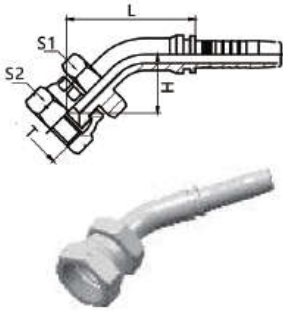

代号 PART NO.	螺纹T THREAD T	软管 HOSE BORE		尺寸 DIMENSIONS			
		公称内径DN	标号 DASH	L	H	S1	S2
Q29641-04-04	G1/4" X19	6	04	42.5	19.5	19	19
Q29641-04-05	G1/4" X19	8	05	47	23	19	19
Q29641-06-04	G3/8" X19	6	04	44.5	21	22	22
Q29641-06-06	G3/8" X19	10	06	51	25	22	22
Q29641-08-06	G1/2" X14	10	06	53	27	27	27
Q29641-08-08	G1/2" X14	13	08	61.5	29	27	27
Q29641-10-10	G5/8" X14	16	10	72.5	32.5	30	30
Q29641-12-10	G3/4" X14	16	10	72.5	33	32	32
Q29641-12-12	G3/4" X14	19	12	79	36	32	32
Q29641-16-16	G1" X11	25	16	90	37	41	41

注：1、表中代号用于编织软管。2、如需用于缠绕软管代号改为Q29642-XX-XX。 Note:1.For use with braided hoses. 2.If use with spiral hoses,hose fitting series number is Q29642-XX-XX.

Q29691

90°日本英制内螺纹60°内锥面
90° JIS GAS Female 60°Cone Seat JIS B8363

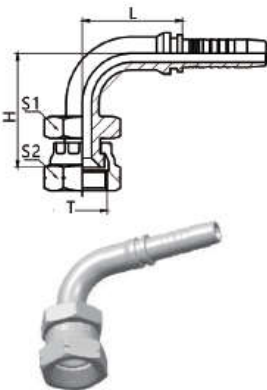

代号 PART NO.	螺纹T THREAD T	软管 HOSE BORE		尺寸 DIMENSIONS			
		公称内径DN	标号 DASH	L	H	S1	S2
Q29691-04-04	G1/4" X19	6	04	30.5	36	19	19
Q29691-04-05	G1/4" X19	8	05	33	39.5	19	19
Q29691-06-04	G3/8" X19	6	04	30.5	37	22	22
Q29691-06-06	G3/8" X19	10	06	36.5	44	22	22
Q29691-08-06	G1/2" X14	10	06	36.5	46	27	27
Q29691-08-08	G1/2" X14	13	08	44	51.5	27	27
Q29691-10-10	G5/8" X14	16	10	55	59	30	30
Q29691-12-10	G3/4" X14	16	10	55	57.5	32	32
Q29691-12-12	G3/4" X14	19	12	63	65.5	32	32
Q29691-16-16	G1" X11	25	16	74	74.5	41	41

注：1、表中代号用于编织软管。2、如需用于缠绕软管代号改为Q29692-XX-XX。 Note:1.For use with braided hoses. 2.If use with spiral hoses,hose fitting series number is Q29692-XX-XX.

Q15611

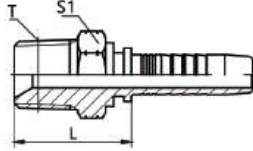
布锥管外螺纹
NPT Male -SAE J516

代号 PART NO.	螺纹T	软管 HOSE BORE		尺寸 DIMENSIONS		
	THREAD T	公称内径DN	标号 DASH	L		S1
Q15611-02-04	NPT1/8" X27	6	04	18.5		12
Q15611-04-04	NPT1/4" X18	6	04	22.5		17
Q15611-04-05	NPT1/4" X18	8	05	22.5		17
Q15611-04-06	NPT1/4" X18	10	06	22.5		17
Q15611-06-04	NPT3/8" X18	6	04	23		19
Q15611-06-05	NPT3/8" X18	8	05	23.5		19
Q15611-06-06	NPT3/8" X18	10	06	23.9		19
Q15611-06-08	NPT3/8" X18	13	08	24.4		19
Q15611-08-06	NPT1/2" X14	10	06	26.5		22
Q15611-08-08	NPT1/2" X14	13	08	26.5		22
Q15611-08-10	NPT1/2" X14	16	10	28		22
Q15611-12-08	NPT3/4" X14	13	08	29		27
Q15611-12-10	NPT3/4" X14	16	10	29.5		27
Q15611-12-12	NPT3/4" X14	19	12	30		27
Q15611-12-16	NPT3/4" X14	25	16	31		32
Q15611-16-10	NPT1" X11.5	16	10	33.5		36
Q15611-16-12	NPT1" X11.5	19	12	34		36
Q15611-16-16	NPT1" X11.5	25	16	35		36
Q15611-20-16	NPT1.1/4" X11.5	25	16	37.5		46
Q15611-20-20	NPT1.1/4" X11.5	32	20	38.5		46
Q15611-24-24	NPT1.1/2" X11.5	38	24	40.5		50
Q15611-32-32	NPT2" X11.5	51	32	43.5		65

注：1、表中代号用于编织软管。2、如需用于缠绕软管代号改为Q15612-XX-XX。 Note: 1. For use with braided hoses. 2. If use with spiral hoses, hose fitting series number is Q15612-XX-XX.

Q15611SW

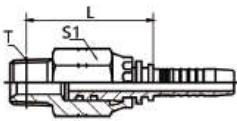
布锥管旋转外螺纹
NPT Swivel Male

代号 PART NO.	螺纹T	软管 HOSE BORE		尺寸 DIMENSIONS		
	THREAD T	公称内径DN	标号 DASH	L		S1
Q15611SW-04-04	NPT1/4" X18	6	04	47.3		19
Q15611SW-06-06	NPT3/8" X18	10	06	54		22
Q15611SW-08-08	NPT1/2" X14	13	08	64		27
Q15611SW-12-12	NPT3/4" X14	19	12	68.5		32

Q15691KSW

90°布锥管旋转外螺纹
90°NPT Swivel Male

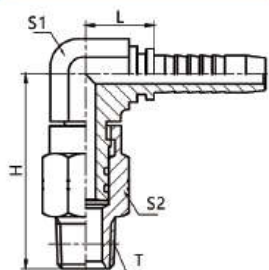

代号 PART NO.	螺纹T	软管 HOSE BORE		尺寸 DIMENSIONS			
	THREAD T	公称内径DN	标号 DASH	L	H	S1	S2
Q15691KSW-04-04	NPT1/4 " X18	6	04	25	59.5	16	19
Q15691KSW-06-06	NPT3/8 " X18	10	06	25	64.5	16	22
Q15691KSW-08-08	NPT1/2 " X14	13	08	28.5	71.5	19	27
Q15691KSW-12-12	NPT3/4 " X14	19	12	36	76.9	27	32

Q14211

美制ORFS外螺纹平面O型圈密封
ORFS Male O-Ring Seal ISO 12151-1 -SAE J1453

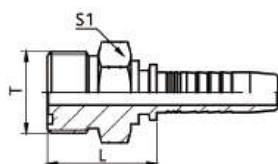

代号 PART NO.	螺纹T	软管 HOSE BORE		尺寸 DIMENSIONS			
	THREAD T	公称内径DN	标号 DASH	L			S1
Q14211-04-04	9/16 " X18	6	04	22.5			17
Q14211-06-04	11/16 " X16	6	04	24			19
Q14211-06-06	11/16 " X16	10	06	24			19
Q14211-08-06	13/16 " X16	10	06	27.5			22
Q14211-08-08	13/16 " X16	13	08	28.5			22
Q14211-08-10	13/16 " X16	16	10	28.5			22
Q14211-10-08	1 " X14	13	08	32.5			27
Q14211-10-10	1 " X14	16	10	33.5			27
Q14211-12-08	1.3/16 " X12	13	08	35.5			32
Q14211-12-10	1.3/16 " X12	16	10	36			32
Q14211-12-12	1.3/16 " X12	19	12	36.5			32
Q14211-16-12	1.7/16 " X12	19	12	37			41
Q14211-16-16	1.7/16 " X12	25	16	38.5			41
Q14211-20-20	1.11/16 " X12	32	20	41.5			46
Q14211-24-24	2 " X12	38	24	43			55

注：1、表中代号用于编织软管。2、如需用于缠绕软管代号改为Q14212-XX-XX。 Note:1.For use with braided hoses. 2.If use with spiral hoses,hose fitting series number is Q14212-XX-XX.

Q24211

美制ORFS内螺纹平面

ORFS Female Flat Seat ISO 12151-1 -SAE J516

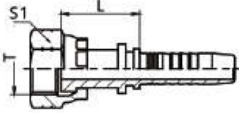

Q24211-T

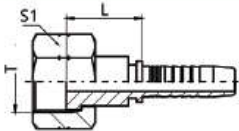

代号 PART NO.	螺纹T THREAD T	软管 HOSE BORE		尺寸 DIMENSIONS		
		公称内径DN	标号 DASH	L	S1	
Q24211-04-04	9/16 " X18	6	04	22.5	17	
Q24211-06-04T	11/16 " X16	6	04	22.5	22	
Q24211-06-05T	11/16 " X16	8	05	23.5	22	
Q24211-06-06	11/16 " X16	10	06	25.5	22	
Q24211-08-06T	13/16 " X16	10	06	25	24	
Q24211-08-08	13/16 " X16	13	08	28.5	24	
Q24211-08-10	13/16 " X16	16	10	29.5	24	
Q24211-10-08T	1 " X14	13	08	29	30	
Q24211-10-10	1 " X14	16	10	33.5	30	
Q24211-12-08T	1.3/16 " X12	13	08	31	36	
Q24211-12-10T	1.3/16 " X12	16	10	32	36	
Q24211-12-12	1.3/16 " X12	19	12	35	36	
Q24211-16-12T	1.7/16 " X12	19	12	34	41	
Q24211-16-16T	1.7/16 " X12	25	16	38	41	
Q24211-20-16T	1.11/16 " X12	25	16	35	50	
Q24211-20-20	1.11/16 " X12	32	20	40	50	
Q24211-24-20T	2 " X12	32	20	36.5	60	
Q24211-24-24T	2 " X12	38	24	36.5	60	

注：1、表中代号用于编织软管。2、如需用于缠绕软管代号改为Q24212-XX-XX。 Note:1.For use with braided hoses. 2.If use with spiral hoses,hose fitting series number is Q24212-XX-XX.

Q24211D

美制ORFS内螺纹平面双六角

ORFS Female Flat Seat Double Hexagon ISO 12151-1 -SAE J516

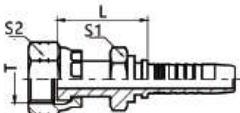

代号 PART NO.	螺纹T THREAD T	软管 HOSE BORE		尺寸 DIMENSIONS		
		公称内径DN	标号 DASH	L	S1	S2
Q24211D-04-04	9/16 " X18	6	04	27.5	14	17
Q24211D-06-04	11/16 " X16	6	04	30.5	19	22
Q24211D-06-05	11/16 " X16	8	05	30.5	19	22
Q24211D-06-06	11/16 " X16	10	06	30.5	19	22
Q24211D-08-06	13/16 " X16	10	06	33	22	24
Q24211D-08-08	13/16 " X16	13	08	33.5	22	24
Q24211D-08-10	13/16 " X16	16	10	34.5	24	24
Q24211D-10-08	1 " X14	13	08	40	27	30
Q24211D-10-10	1 " X14	16	10	41	27	30
Q24211D-12-08	1.3/16 " X12	13	08	31	36	36
Q24211D-12-10	1.3/16 " X12	16	10	32	36	36
Q24211D-12-12	1.3/16 " X12	19	12	35	36	36
Q24211D-16-16	1.7/16 " X12	25	16	35	41	41
Q24211D-20-16	1.11/16 " X12	25	16	35	50	50
Q24211D-20-20	1.11/16 " X12	32	20	40	50	50
Q24211D-24-20	2 " X12	32	20	36.5	60	60
Q24211D-24-24	2 " X12	38	24	36.5	60	60

注：1、表中代号用于编织软管。2、如需用于缠绕软管代号改为Q24212D-XX-XX。 Note:1.For use with braided hoses. 2.If use with spiral hoses,hose fitting series number is Q24212D-XX-XX.

Q24241

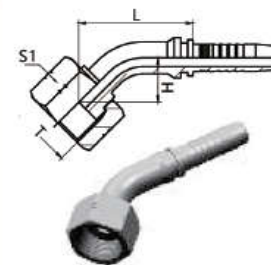

Q24241-T

45°美制ORFS内螺纹平面
45°ORFS Female Flat Seat ISO 12151-1- SAE J516

代号 PART NO.	螺纹T THREAD T	软管 HOSE BORE		尺寸 DIMENSIONS		
		公称内径DN	标号 DASH	L	H	S1
Q24241-04-04	9/16" X18	6	04	33.8	10	17
Q24241-06-04T	11/16" X16	6	04	34.8	11	22
Q24241-06-05T	11/16" X16	8	05	34.7	11	22
Q24241-06-06	11/16" X16	10	06	37	11	22
Q24241-08-06T	13/16" X16	10	06	41	15	24
Q24241-08-08	13/16" X16	13	08	46.3	15	24
Q24241-08-10	13/16" X16	16	10	55.2	16	24
Q24241-10-08T	1" X14	13	08	47.3	16	30
Q24241-10-10	1" X14	16	10	55.2	16	30
Q24241-12-08T	1.3/16" X12	13	08	52.3	21	36
Q24241-12-10T	1.3/16" X12	16	10	60.2	21	36
Q24241-12-12	1.3/16" X12	19	12	63.7	21	36
Q24241-16-12T	1.7/16" X12	19	12	66.7	24	41
Q24241-16-16T	1.7/16" X12	25	16	73.4	24	41
Q24241-20-16T	1.11/16" X12	25	16	81.4	32	50
Q24241-20-20	1.11/16" X12	32	20	92.8	32	50
Q24241-24-20T	2" X12	32	20	102.8	42	60
Q24241-24-24T	2" X12	38	24	113.1	42	60

注：1、表中代号用于编织软管。2、如需用于缠绕软管代号改为Q24242-XX-XX。 Note:1.For use with braided hoses. 2.If use with spiral hoses,hose fitting series number is Q24242-XX-XX.

Q24291

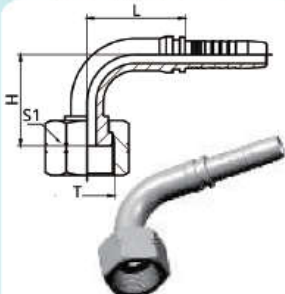

Q24291-T

90°美制ORFS内螺纹平面
90°ORFS Female Flat Seat ISO 12151-1- SAE J516

代号 PART NO.	螺纹T THREAD T	软管 HOSE BORE		尺寸 DIMENSIONS		
		公称内径DN	标号 DASH	L	H	S1
Q24291-04-04	9/16" X18	6	04	32	32	17
Q24291-06-04T	11/16" X16	6	04	32	38	22
Q24291-06-05T	11/16" X16	8	05	32.5	38	22
Q24291-06-06	11/16" X16	10	06	36.5	38	22
Q24291-08-06T	13/16" X16	10	06	36.5	41	24
Q24291-08-08	13/16" X16	13	08	44.5	41	24
Q24291-08-10	13/16" X16	16	10	55	47	24
Q24291-10-08T	1" X14	13	08	44.5	47	30
Q24291-10-10	1" X14	16	10	55	47	30
Q24291-12-08T	1.3/16" X12	13	08	44.5	58	36
Q24291-12-10T	1.3/16" X12	16	10	55	58	36
Q24291-12-12	1.3/16" X12	19	12	62	58	36
Q24291-16-12T	1.7/16" X12	19	12	62	71	41
Q24291-16-16T	1.7/16" X12	25	16	74	71	41
Q24291-20-16T	1.11/16" X12	25	16	74	78	50
Q24291-20-20	1.11/16" X12	32	20	91.5	78	50
Q24291-24-20T	2" X12	32	20	91.5	86	60
Q24291-24-24T	2" X12	38	24	108	86	60

注：1、表中代号用于编织软管。2、如需用于缠绕软管代号改为Q24292-XX-XX。 Note:1.For use with braided hoses. 2.If use with spiral hoses,hose fitting series number is Q24292-XX-XX.

Q16711

美制JIC外螺纹74°外锥面
JIC Male 74° Cone ISO 12151-5 -SAE J514

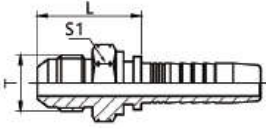

代号 PART NO.	螺纹T THREAD T	软管 HOSE BORE		尺寸 DIMENSIONS			
		公称内径DN	标号 DASH	L			S1
Q16711-04-04	7/16 " X20	6	04	26.5			12
Q16711-05-04	1/2 " X20	6	04	26.5			14
Q16711-05-05	1/2 " X20	8	05	26.5			14
Q16711-05-06	1/2 " X20	10	06	26.5			17
Q16711-06-04	9/16 " X18	6	04	26.5			17
Q16711-06-05	9/16 " X18	8	05	26.5			17
Q16711-06-06	9/16 " X18	10	06	26.5			17
Q16711-08-06	3/4 " X16	10	06	31			22
Q16711-08-08	3/4 " X16	13	08	31.5			22
Q16711-10-06	7/8 " X14	10	06	32			24
Q16711-10-08	7/8 " X14	13	08	34.5			24
Q16711-10-10	7/8 " X14	16	10	35.5			24
Q16711-12-08	1.1/16 " X12	13	08	39			27
Q16711-12-10	1.1/16 " X12	16	10	40			27
Q16711-12-12	1.1/16 " X12	19	12	40			27
Q16711-12-16	1.1/16 " X12	25	16	41			32
Q16711-14-10	1.3/16 " X12	16	10	40			32
Q16711-14-12	1.3/16 " X12	19	12	40.5			32
QS16711-16-12	1.5/16 " X12	19	12	42.5			36
QS16711-16-16	1.5/16 " X12	25	16	43.5			36
QS16711-20-16	1.5/8 " X12	25	16	46			46
QS16711-20-20	1.5/8 " X12	32	20	47.5			46
QS16711-24-20	1.7/8 " X12	32	20	53.5			50
QS16711-24-24	1.7/8 " X12	38	24	53			50
QS16711-32-32	2.1/2 " X12	51	32	64			65

注：1、表中代号用于编织软管。2、如需用于缠绕软管代号改为Q16712-XX-XX。 Note:1.For use with braided hoses. 2.If use with spiral hoses,hose fitting series number is Q16712-XX-XX.

Q26711

美制JIC内螺纹74°内锥面
JIC Female 74° Cone Seat ISO 12151-5 -SAE J514

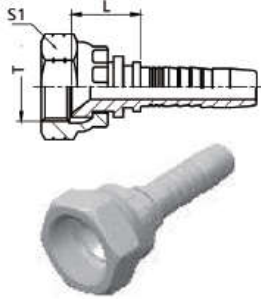

代号 PA RT NO.	螺纹T THREAD T	软管 HOSE BORE		尺寸 DIMENSIONS		
		公称内径DN	标号 DASH	L		S1
Q26711-04-04	7/16 " X20	6	04	15		14
Q26711-05-04	1/2 " X20	6	04	15.5		17
Q26711-05-05	1/2 " X20	8	05	15.5		17
Q26711-06-04T	9/16 " X18	6	04	15.5		19
Q26711-06-05	9/16 " X18	8	05	15.5		19
Q26711-06-06	9/16 " X18	10	06	15.5		19
Q26711-07-06	9/16 " X18	13	08	16		19
Q26711-08-06T	3/4 " X16	10	06	17.5		22
Q26711-08-08	3/4 " X16	13	08	18		22
Q26711-08-10	3/4 " X16	16	10	19		22
Q26711-10-08T	7/8 " X14	13	08	18		27
Q26711-10-10	7/8 " X14	16	10	20		27
Q26711-10-12	7/8 " X14	19	12	20		27
Q26711-12-08T	1.1/16 " X12	13	08	20		32
Q26711-12-10T	1.1/16 " X12	16	10	21.5		32
Q26711-12-12	1.1/16 " X12	19	12	21.5		32
Q26711-14-12T	1.3/16 " X12	19	12	21.5		36
Q26711-16-12T	1.5/16 " X12	19	12	22		41
Q26711-16-16	1.5/16 " X12	25	16	23		41
Q26711-20-16T	1.5/8 " X12	25	16	25		50
Q26711-20-20	1.5/8 " X12	32	20	26		50
Q26711-24-20T	1.7/8 " X12	32	20	26.5		60
Q26711-24-24	1.7/8 " X12	38	24	26.5		60
Q26711-32-24T	2.1/2 " X12	38	24	26.5		75
Q26711-32-32T	2.1/2 " X12	51	32	27		75

注：1、表中代号用于编织软管。2、如需用于缠绕软管代号改为Q26712-XX-XX。 Note:1.For use with braided hoses. 2.If use with spiral hoses,hose fitting series number is Q26712-XX-XX.

Q26711-T

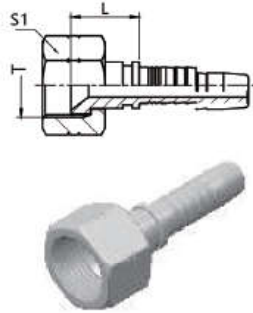

Q26711D

美制JIC内螺纹74°内锥面双六角
JIC Female 74° Cone Seat ISO 12151-5 Double Hexagon SAE J514

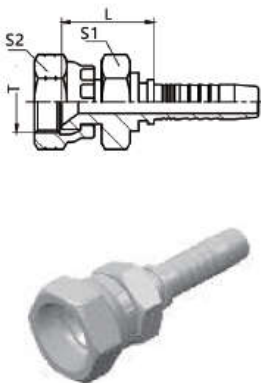

代号 PART NO.	螺纹T THREAD T	软管 HOSE BORE		尺寸 DIMENSIONS		
		公称内径DN	标号 DASH	L	S1	S2
Q26711D-04-04	7/16 " X20	6	04	20	14	14
Q26711D-05-04	1/2 " X20	6	04	20.5	17	17
Q26711D-06-04	9/16 " X18	6	04	21	19	19
Q26711D-06-06	9/16 " X18	10	06	21	19	19
Q26711D-08-06	3/4 " X16	10	06	25	24	22
Q26711D-08-08	3/4 " X16	13	08	24.5	24	22
Q26711D-08-10	3/4 " X16	16	10	25.5	24	22
Q26711D-10-08	7/8 " X14	13	08	28	27	27
Q26711D-10-10	7/8 " X14	16	10	29	27	27
Q26711D-12-12	1.1/16 " X12	19	12	31.5	32	32
Q26711D-16-12	1.5/16 " X12	19	12	33.5	41	41
Q26711D-16-16	1.5/16 " X12	25	16	34.5	41	41
Q26711D-16-20	1.5/16 " X12	32	20	36.5	41	41
Q26711D-20-20	1.5/8 " X12	32	20	39	50	50

注：1、表中代号用于编织软管。2、如需用于缠绕软管代号改为Q26712D-XX-XX。 Note:1.For use with braided hoses. 2.If use with spiral hoses,hose fitting series number is Q26712D-XX-XX.

Q26711D-SM

美制JIC内螺纹74°内锥面双六角
JIC Female 74° Cone Seat ISO 12151-5 Double Hexagon SAE J514

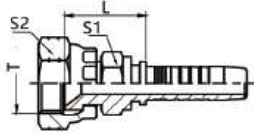

代号 PART NO.	螺纹T	软管 HOSE BORE		尺寸 DIMENSIONS		
	THREAD T	公称内径DN	标号 DASH	L	S1	S2
Q26711D-04-04SM	7/16" X20	6	04	20	12	14
Q26711D-05-04SM	1/2" X20	6	04	20.5	12	17
Q26711D-06-04SM	9/16" X18	6	04	21	14	19
Q26711D-06-06SM	9/16" X18	10	06	21	17	19
Q26711D-08-06SM	3/4" X16	10	06	25	19	22
Q26711D-08-08SM	3/4" X16	13	08	24.5	22	22
Q26711D-08-10SM	3/4" X16	16	10	25.5	22	22
Q26711D-10-08SM	7/8" X14	13	08	24	22	27
Q26711D-10-10SM	7/8" X14	16	10	27	22	27
Q26711D-12-12SM	1.1/16" X12	19	12	31.5	27	32
Q26711D-16-12SM	1.5/16" X12	19	12	31.5	32	41
Q26711D-16-16SM	1.5/16" X12	25	16	32.5	32	41
Q26711D-20-20SM	1.5/8" X12	32	20	37	41	50

注：1、表中代号用于编织软管。2、如需用于缠绕软管代号改为Q26712D-XX-XXSM。 Note:1.For use with braided hoses. 2.If use with spiral hoses,hose fitting series number is Q26712D-XX-XXSM.

Q26741

45°美制JIC内螺纹74°内锥面
45° JIC Female 74° Cone Seat ISO 12151-5 -SAE J514

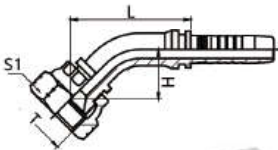

Q26741-T

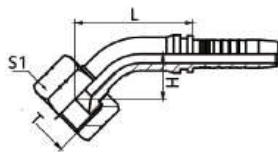

代号 PART NO.	螺纹T	软管 HOSE BORE		尺寸 DIMENSIONS		
	THREAD T	公称内径DN	标号 DASH	L	H	S1
Q26741-04-04	7/16" X20	6	04	33.8	10	14
Q26741-05-04	1/2" X20	6	04	33.8	10	17
Q26741-05-05	1/2" X20	8	05	33.7	10	17
Q26741-06-04T	9/16" X18	6	04	34.8	11	19
Q26741-06-05	9/16" X18	8	05	34.7	11	19
Q26741-06-06	9/16" X18	10	06	37	11	19
Q26741-06-08	9/16" X18	13	08	46.3	15	19
Q26741-08-06T	3/4" X16	10	06	41	15	22
Q26741-08-08	3/4" X16	13	08	46.3	15	22
Q26741-08-10	3/4" X16	16	10	55.2	16	22
Q26741-10-08T	7/8" X14	13	08	47.3	16	27
Q26741-10-10	7/8" X14	16	10	55.2	16	27
Q26741-10-12	7/8" X14	19	12	63.7	21	27
Q26741-12-08T	1.1/16" X12	13	08	52.3	21	32
Q26741-12-10T	1.1/16" X12	16	10	60.2	21	32
Q26741-12-12	1.1/16" X12	19	12	63.7	21	32
Q26741-14-12T	1.3/16" X12	19	12	73.5	31	36
Q26741-16-12T	1.5/16" X12	19	12	66.7	24	41
Q26741-16-16	1.5/16" X12	25	16	73.4	24	41
Q26741-20-16T	1.5/8" X12	25	16	81.4	32	50
Q26741-20-20	1.5/8" X12	32	20	92.8	32	50
Q26741-24-20T	1.7/8" X12	32	20	102.8	42	60
Q26741-24-24	1.7/8" X12	38	24	113.1	42	60
Q26741-32-24T	2.1/2" X12	38	24	122.6	51.5	75
Q26741-32-32T	2.1/2" X12	51	32	136.5	51.5	75

注：1、表中代号用于编织软管。2、如需用于缠绕软管代号改为Q26742-XX-XX。 Note:1.For use with braided hoses. 2.If use with spiral hoses,hose fitting series number is Q26742-XX-XX.

Q26791

90°美制JIC 内螺纹74°内锥面

90°JIC Female 74° Cone Seat ISO 12151-5 -SAE J514

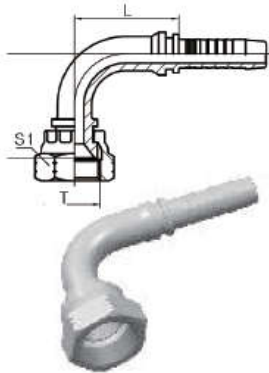

Q26791-T

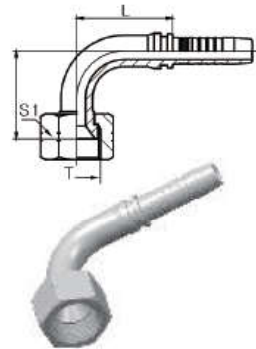

代号 PART NO.	螺纹T THREAD T	软管 HOSE BORE		尺寸 DIMENSIONS		
		公称内径DN	标号 DASH	L	H	S1
Q26791-04-04	7/16 " X20	6	04	32	32	14
Q26791-05-04	1/2 " X20	6	04	32	32	17
Q26791-05-05	1/2 " X20	8	05	32.5	32	17
Q26791-06-04T	9/16 " X18	6	04	32	38	19
Q26791-06-05	9/16 " X18	8	05	32.5	38	19
Q26791-06-06	9/16 " X18	10	06	36.5	38	19
Q26791-06-08	9/16 " X18	13	08	44.5	41	19
Q26791-08-06T	3/4 " X16	10	06	36.5	41	22
Q26791-08-08	3/4 " X16	13	08	44.5	41	22
Q26791-08-10	3/4 " X16	16	10	55	47	22
Q26791-10-08T	7/8 " X14	13	08	44.5	47	27
Q26791-10-10	7/8 " X14	16	10	55	47	27
Q26791-10-12	7/8 " X14	19	12	62	58	27
Q26791-12-08T	1.1/16 " X12	13	08	44.5	58	32
Q26791-12-10T	1.1/16 " X12	16	10	55	58	32
Q26791-12-12	1.1/16 " X12	19	12	62	58	32
Q26791-14-12T	1.3/16 " X12	19	12	64	63.5	36
Q26791-16-12T	1.5/16 " X12	19	12	62	71	41
Q26791-16-16	1.5/16 " X12	25	16	74	71	41
Q26791-20-16T	1.5/8 " X12	25	16	74	78	50
Q26791-20-20	1.5/8 " X12	32	20	91.5	78	50
Q26791-24-20T	1.7/8 " X12	32	20	91.5	86	60
Q26791-24-24	1.7/8 " X12	38	24	108	86	60
Q26791-32-24T	2.1/2 " X12	38	24	108	140	75
Q26791-32-32T	2.1/2 " X12	51	32	133.8	140	75

注：1、表中代号用于编织软管。2、如需用于缠绕软管代号改为Q26792-XX-XX。 Note:1.For use with braided hoses. 2.If use with spiral hoses,hose fitting series number is Q26792-XX-XX.

Q26791-K

90°美制短身JIC 内螺纹74°内锥面

90°JIC Compact Female 74° Cone Seat SAE J514

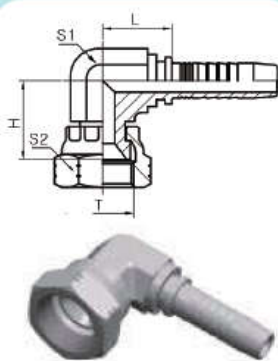

代号 PART NO.	螺纹T THREAD T	软管 HOSE BORE		尺寸 DIMENSIONS			
		公称内径DN	标号 DASH	L	H	S1	S2
Q26791K-04-04	7/16 " X20	6	04	17.5	18	11	14
Q26791K-05-05	1/2 " X20	8	05	19.5	18	11	17
Q26791K-06-04	9/16 " X18	6	04	19	21	14	19
Q26791K-06-06	9/16 " X18	10	06	20	21	16	19
Q26791K-08-06	3/4 " X16	10	06	23	25	19	24
Q26791K-08-08	3/4 " X16	13	08	23.5	25	22	24
Q26791K-10-08	7/8 " X14	13	08	23.5	27.5	22	27
Q26791K-10-10	7/8 " X14	16	10	25	27.5	22	27
Q26791K-12-12	1.1/16 " X12	19	12	27.5	30	27	32
Q26791K-16-16	1.5/16 " X12	25	16	43	34.3	33	41

注：1、表中代号用于编织软管。2、如需用于缠绕软管代号改为Q26792K-XX-XX。 Note:1.For use with braided hoses. 2.If use with spiral hoses,hose fitting series number is Q26792K-XX-XX.

Q20011-T

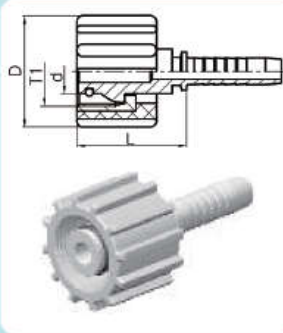
公制内螺纹高压水管接头
Metric Female Waterwash Inserts

代号 PART NO.	螺纹T	软管 HOSE BORE		尺寸 DIMENSIONS		
	THREAD T	公称内径DN	标号 DASH	L	D	d
Q20011-22-04T	M22X1.5	6	04	35	34.5	14
Q20011-22-05T	M22X1.5	8	05	35	34.5	14
Q20011-22-06T	M22X1.5	10	06	35	34.5	14

Q17811-S

美制外螺纹45°扩口
SAE 24° J512 FLARE

代号 PART NO.	软管 HOSE BORE		尺寸 DIMENSIONS		
	公称内径 DN	标号 DASH	L	S1	
Q17811-04-04S	6	04	43	12	
Q17811-05-04S	6	04	46.5	14	
Q17811-06-05S	8	05	48	17	
Q17811-06-06S	10	06	48	17	
Q17811-08-06S	10	06	50	19	
Q17811-08-08S	13	08	51	19	
Q17811-10-08S	13	08	52.5	24	
Q17811-10-10S	16	10	53	24	

Q87311

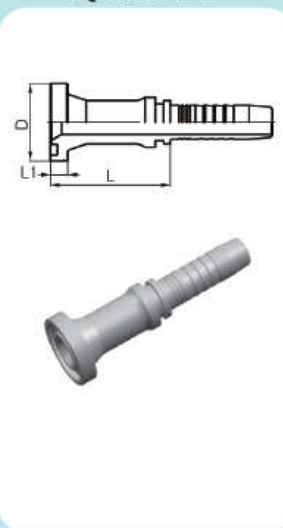
SAE法兰 3000 PSI 61型
SAE Flange 3000 PSI Code 61 ISO 12151-3-SAE J516

代号 PART NO.	螺纹T	软管 HOSE BORE		尺寸 DIMENSIONS		
	THREAD T	公称内径DN	标号 DASH	L	D	L1
Q87311-08-08	1/2 "	13	08	46	30.2	6.73
Q87311-12-08	3/4 "	13	08	47	38.1	6.73
Q87311-12-10	3/4 "	16	10	48	38.1	6.73
Q87311-12-12	3/4 "	19	12	48	38.1	6.73
Q87311-12-16	3/4 "	25	16	49	38.1	6.73
Q87311-16-12	1 "	19	12	51	44.4	8
Q87311-16-16	1 "	25	16	52	44.4	8
Q87311-16-20	1 "	32	20	53	44.4	8
Q87311-20-16	1.1/4 "	25	16	57	50.8	8
Q87311-20-20	1.1/4 "	32	20	58	50.8	8
Q87311-24-20	1.1/2 "	32	20	68	60.3	8
Q87311-24-24	1.1/2 "	38	24	68	60.3	8
Q87311-32-24	2 "	38	24	66	71.4	9.53
Q87311-32-32	2 "	51	32	66	71.4	9.53

注：1、表中代号用于编织软管。2、如需用于缠绕软管代号改为Q87312-XX-XX。 Note:1.For use with braided hoses. 2.If use with spiral hoses,hose fitting series number is Q87312-XX-XX.

Q87341

45°SAE法兰 3000 PSI 61型

45°SAE Flange 3000 PSI Code 61 ISO 12151-3-SAE J516

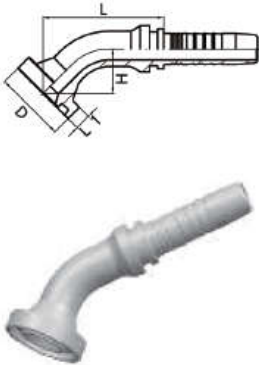

代号 PART NO.	螺纹T	软管 HOSE BORE		尺寸 DIMENSIONS			
	THREAD T	公称内径DN	标号 DASH	L	H	D	L1
Q87341-08-08	1/2 "	13	08	50.3	19	30.2	6.73
Q87341-12-08	3/4 "	13	08	57.3	26	38.1	6.73
Q87341-12-10	3/4 "	16	10	65.2	26	38.1	6.73
Q87341-12-12	3/4 "	19	12	68.7	26	38.1	6.73
Q87341-12-16	3/4 "	25	16	79.4	30	38.1	6.73
Q87341-16-12	1 "	19	12	74.7	32	44.4	8
Q87341-16-16	1 "	25	16	81.4	32	44.4	8
Q87341-16-20	1 "	32	20	95.8	35	44.4	8
Q87341-20-16	1.1/4 "	25	16	87.4	38	50.8	8
Q87341-20-20	1.1/4 "	32	20	98.8	38	50.8	8
Q87341-24-20	1.1/2 "	32	20	104.75	44	60.3	8
Q87341-24-24	1.1/2 "	38	24	115.1	44	60.3	8
Q87341-32-24	2 "	38	24	127.1	56	71.4	9.53
Q87341-32-32	2 "	51	32	141	56	71.4	9.53

注：1、表中代号用于编织软管。2、如需用于缠绕软管代号改为Q87342-XX-XX。 Note:1.For use with braided hoses. 2.If use with spiral hoses,hose fitting series number is Q87342-XX-XX.

Q87391

90°SAE法兰 3000 PSI 61型

90°SAE Flange 3000 PSI Code 61 ISO 12151-3-SAE J516

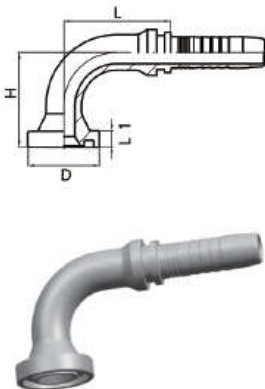

代号 PART NO.	螺纹T	软管 HOSE BORE		尺寸 DIMENSIONS			
	THREAD T	公称内径DN	标号 DASH	L	H	D	L1
Q87391-08-08	1/2 "	13	08	44.5	40	30.2	6.73
Q87391-12-08	3/4 "	13	08	44.5	58	38.1	6.73
Q87391-12-10	3/4 "	16	10	55	58	38.1	6.73
Q87391-12-12	3/4 "	19	12	62	58	38.1	6.73
Q87391-12-16	3/4 "	25	16	74	68	38.1	6.73
Q87391-16-12	1 "	19	12	62	70	44.4	8
Q87391-16-16	1 "	25	16	74	70	44.4	8
Q87391-16-20	1 "	32	20	91.5	82	44.4	8
Q87391-20-16	1.1/4 "	25	16	74	90	50.8	8
Q87391-20-20	1.1/4 "	32	20	91.5	90	50.8	8
Q87391-24-20	1.1/2 "	32	20	91.5	104	60.3	8
Q87391-24-24	1.1/2 "	38	24	108	104	60.3	8
Q87391-32-24	2 "	38	24	108	138	71.4	9.53
Q87391-32-32	2 "	51	32	133.8	138	71.4	9.53

注：1、表中代号用于编织软管。2、如需用于缠绕软管代号改为Q87392-XX-XX。 Note:1.For use with braided hoses. 2.If use with spiral hoses,hose fitting series number is Q87392-XX-XX.

Q87611

SAE法兰 6000 PSI 62型

SAE Flange 6000 PSI Code 62 ISO 12151-3-SAE J516

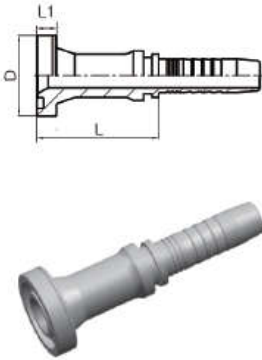

代号 PART NO.	法兰型号 FLANGE SIZE	软管 HOSE BORE		尺寸 DIMENSIONS		
		公称内径DN	标号 DASH	L	D	L1
Q87611-08-08	1/2"	13	08	47	31.7	7.75
Q87611-12-10	3/4"	16	10	51	41.3	8.76
Q87611-12-12	3/4"	19	12	51	41.3	8.76
Q87611-16-12	1"	19	12	56	47.6	9.53
Q87611-16-16	1"	25	16	57	47.6	9.53
Q87611-16-20	1"	32	20	58	47.6	9.53
Q87611-20-16	1.1/4"	25	16	65	54	10.29
Q87611-20-20	1.1/4"	32	20	66	54	10.29
Q87611-24-20	1.1/2"	32	20	75	63.5	12.57
Q87611-24-24	1.1/2"	38	24	75	63.5	12.57
Q87611-32-24	2"	38	24	85	79.4	12.57
Q87611-32-32	2"	51	32	85	79.4	12.57

注：1、表中代号用于编织软管。2、如需用于缠绕软管代号改为Q87612-XX-XX。 Note: 1. For use with braided hoses. 2. If use with spiral hoses, hose fitting series number is Q87612-XX-XX.

Q87641

45°SAE法兰 6000 PSI 62型

45°SAE Flange 6000 PSI Code 62 ISO 12151-3-SAE J516

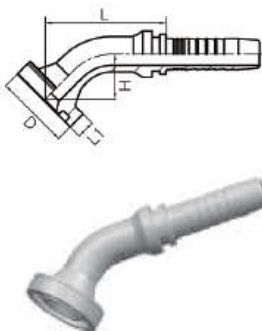

代号 PART NO.	法兰型号 FLANGE SIZE	软管 HOSE BORE		尺寸 DIMENSIONS			
		公称内径DN	标号 DASH	L	H	D	L1
Q87641-08-08	1/2"	13	08	50.3	19	31.7	7.75
Q87641-12-10	3/4"	16	10	65.2	26	41.3	8.76
Q87641-12-12	3/4"	19	12	68.7	26	41.3	8.76
Q87641-16-12	1"	19	12	74.7	32	47.6	9.53
Q87641-16-16	1"	25	16	81.4	32	47.6	9.53
Q87641-16-20	1"	32	20	95.8	35	47.6	9.53
Q87641-20-16	1.1/4"	25	16	87.4	38	54	10.29
Q87641-20-20	1.1/4"	32	20	98.8	38	54	10.29
Q87641-24-20	1.1/2"	32	20	104.8	44	63.5	12.57
Q87641-24-24	1.1/2"	38	24	115.1	44	63.5	12.57
Q87641-32-24	2"	38	24	127.1	56	79.4	12.57
Q87641-32-32	2"	51	32	141	56	79.4	12.57

注：1、表中代号用于编织软管。2、如需用于缠绕软管代号改为Q87642-XX-XX。 Note: 1. For use with braided hoses. 2. If use with spiral hoses, hose fitting series number is Q87642-XX-XX.

Q87691

90°SAE法兰 6000 PSI 62型
90°SAE Flange 6000 PSI Code 62 ISO 12151-3-SAE J516

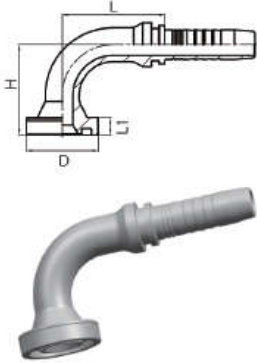

代号 PART NO.	法兰型号 FLANGE SIZE	软管 HOSE BORE		尺寸 DIMENSIONS			
		公称内径DN	标号 DASH	L	H	D	L1
Q87691-08-08	1/2"	13	08	44.5	40	31.7	7.75
Q87691-12-10	3/4"	16	10	55	58	41.3	8.76
Q87691-12-12	3/4"	19	12	62	58	41.3	8.76
Q87691-16-12	1"	19	12	62	70	47.6	9.53
Q87691-16-16	1"	25	16	74	70	47.6	9.53
Q87691-16-20	1"	32	20	91.5	82	47.6	9.53
Q87691-20-16	1.1/4"	25	16	74	90	54	10.29
Q87691-20-20	1.1/4"	32	20	91.5	90	54	10.29
Q87691-24-20	1.1/2"	32	20	91.5	104	63.5	12.57
Q87691-24-24	1.1/2"	38	24	108	104	63.5	12.57
Q87691-32-24	2"	38	24	108	138	79.4	12.57
Q87691-32-32	2"	51	32	133.8	138	79.4	12.57

注：1、表中代号用于编织软管。2、如需用于缠绕软管代号改为Q87692-XX-XX。 Note:1.For use with braided hoses. 2.If use with spiral hoses,hose fitting series number is Q87692-XX-XX.

Q60011

矿用快速软管接头
MT Staple Ockclip Fastener Male

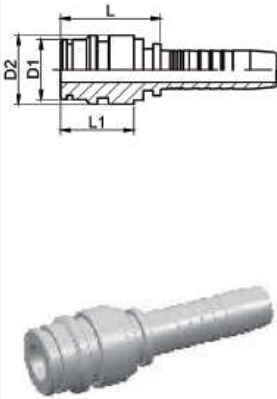

代号 PART NO.	规格 SIZE	尺寸 DIMENSIONS			
		A1	D1	D2	
Q60011-04-04D	1/4 "	36.5	15	10	
Q60011-05-05D	5/16 "	36.5	20	14	
Q60011-06-06D	3/8 "	36.5	20	14	
Q60011-08-08D	1/2 "	37	24	18	
Q60011-10-10D	5/8 "	38	26	21	
Q60011-12-12D	3/4 "	38	29	24	
Q60011-16-16D	1 "	44	39	31	
Q60011-20-20D	1.1/4 "	46	46	38	
Q60011-24-24D	1.1/2 "	51	55	47	
Q60011-32-32D	2 "	51	64	56	
Q60011-20-20G	1.1/4 "	66	45.5	38	
Q60011-24-24G	1.1/2 "	72	54.5	44	
Q60011-32-32G	2 "	72	63.5	50	
Q60011-04-04K	1/4 "	33.5	15	11	
Q60011-05-05K	5/16 "	33.5	18	13	
Q60011-06-06K	3/8 "	33.5	18	15	
Q60011-08-08K	1/2 "	33.5	22	18	
Q60011-10-10K	5/8 "	38	25	20	
Q60011-12-12K	3/4 "	40	28	24	
Q60011-16-16K	1 "	40	35	30	
Q60011-20-20K	1.1/4 "	42	42	38	

注：1、表中代号用于编织软管。2、如需用于缠绕软管代号改为Q60012-XX-XX。3、D:SAE通用类；G:SAE高压类；K:煤标。 Note:1.For use with braided hoses. 2.If use with spiral hoses,hose fitting series number is Q60012-XX-XX. 3.D:SAEGeneral; G:SAEHigh pressure; K:MT

Q70011

公制铰接体
Metric Banjo DIN 7642

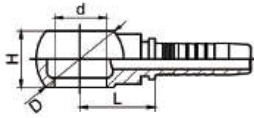

代号 PART NO.	螺栓 BOLT	软管 HOSE BORE		尺寸 DIMENSIONS			
		公称内径DN	标号 DASH	L	d	D	H
Q70011-10-03	M10X1	5	03	17	10.1	17	10
Q70011-10-04	M10X1	6	04	19.5	10.1	17	10
Q70011-12-04	M12X1.5	6	04	21	12.1	20	12
Q70011-12-05	M12X1.5	8	05	22.5	12.1	22	12
Q70011-12-06	M12X1.5	10	06	21	12.1	20	12
Q70011-14-04	M14X1.5	6	04	24.5	14.1	24	14
Q70011-14-05	M14X1.5	8	05	21	14.1	24	14
Q70011-14-06	M14X1.5	10	06	24.5	14.1	24	14
Q70011-16-04	M16X1.5	6	04	24	16.1	28	18
Q70011-16-05	M16X1.5	8	05	24	16.1	28	18
Q70011-16-06	M16X1.5	10	06	24	16.1	28	18
Q70011-18-04	M18X1.5	6	04	30.5	18.1	32	20
Q70011-18-05	M18X1.5	8	05	24.5	18.1	32	20
Q70011-18-06	M18X1.5	10	06	24.5	18.1	32	20
Q70011-18-08	M18X1.5	13	08	25	18.1	32	20
Q70011-22-06	M22X1.5	10	06	27	22.1	35	22
Q70011-22-08	M22X1.5	13	08	27.5	22.1	35	22
Q70011-22-10	M22X1.5	16	10	28	22.1	39	22
Q70011-26-12	M26X1.5	19	12	36.5	26.1	45	29
Q70011-30-16	M30X1.5	25	16	40	30.1	54	36
Q70011-30-20	M30X1.5	32	20	41	30.1	54	36

注：1、表中代号用于编织软管。2、如需用于缠绕软管代号改为Q70012-XX-XX。 Note:1.For use with braided hoses. 2.If use with spiral hoses,hose fitting series number is Q70012-XX-XX.

Q72011

英制铰接体
BSP Banjo

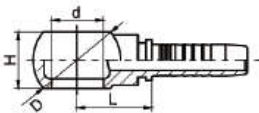

代号 PART NO.	螺栓 BOLT	软管 HOSE BORE		尺寸 DIMENSIONS			
		公称内径DN	标号 DASH	L	d	D	H
Q72011-04-04	G1/4 " X19	6	04	19.5	13.3	24	14
Q72011-04-05	G1/4 " X19	8	05	19.5	13.3	24	14
Q72011-04-06	G1/4 " X19	10	06	22	13.3	24	14
Q72011-06-04	G3/8 " X19	6	04	22	16.7	29	18
Q72011-06-05	G3/8 " X19	8	05	22	16.7	29	20
Q72011-06-06	G3/8 " X19	10	06	22	16.7	29	20
Q72011-06-08	G3/8 " X19	13	08	23.5	16.7	28	20
Q72011-08-05	G1/2 " X14	8	05	27.5	21	35	22
Q72011-08-06	G1/2 " X14	10	06	27.5	21.2	35	22
Q72011-08-08	G1/2 " X14	13	08	27.5	21.2	36	25
Q72011-08-10	G1/2 " X14	16	10	28.5	21.2	36	25
Q72011-10-10	G5/8 " X14	16	10	28	23	40	27
Q72011-12-10	G3/4 " X14	16	10	32	26.5	48	31
Q72011-12-12	G3/4 " X14	19	12	32	26.5	48	31
Q72011-16-08	G1 " X11	13	08	40	33.3	48	36
Q72011-16-12	G1 " X11	19	12	40	33.3	54	36
Q72011-16-16	G1 " X11	25	16	41	33.3	54	36

注：1、表中代号用于编织软管。2、如需用于缠绕软管代号改为Q72012-XX-XX。 Note:1.For use with braided hoses. 2.If use with spiral hoses,hose fitting series number is Q72012-XX-XX.

Q700M

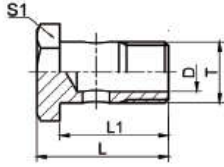
公制铰接螺栓
Metric Bolt DIN 7643

代号 PART NO.	螺纹T THREAD T	尺寸 DIMENSIONS		
		L	L1	S1
Q700M-10	M10X1	19.5	6	14
Q700M-12	M12X1.5	24.5	6	17
Q700M-14	M14X1.5	26	6	19
Q700M-16	M16X1.5	28.5	6	22
Q700M-18	M18X1.5	32.5	6	24
Q700M-22	M22X1.5	39	8	27
Q700M-26	M26X1.5	46	10	32
Q700M-30	M30X1.5	51	10	36

注：配S70011使用。Note: USE for S70011 series

Q720B

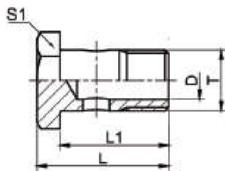
英制铰接螺栓
BSP Bolt

代号 PART NO.	螺纹T THREAD T	尺寸 DIMENSIONS		
		L	L1	S1
Q720B-02	G1/8 " X28	29.5	4.8	14
Q720B-04	G1/4 " X19	28.5	6	19
Q720B-06	G3/8 " X19	38.5	7	22
Q720B-08	G1/2 " X14	44	8.5	27
Q720B-10	G5/8 " X14	48.5	10	30
Q720B-12	G3/4 " X14	46	10	32
Q720B-16	G1 " X11	68.5	13	41

注：配S72011使用。Note: USE for S72011 series

Q90011

双面连接芯
Double Connector

代号 PART NO.	软管 HOSE BORE		尺寸 DIMENSIONS		
	公称内径DN	标号 DASH	L		
Q90011-04	6	04	12		
Q90011-05	8	05	12		
Q90011-06	10	06	12		
Q90011-08	13	08	13		
QS90011-10	16	10	16		
QS90011-12	19	12	16		
QS90011-16	25	16	23		
QS90011-20	32	20	26		
QS90011-24	38	24	26		
QS90011-32	51	32	26		

注：1、表中代号用于编织软管。2、如需用于缠绕软管代号改为Q90012-XX-XX。 Note: 1. For use with braided hoses. 2. If use with spiral hoses, hose fitting series number is Q90012-XX-XX.

Q20513-T

公制内螺纹24°锥 带O型圈重系列

Metric Female 24° Cone O-Ring H.T. ISO 12151-2-DIN 3865

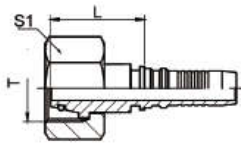

代号 PART NO.	螺纹T	软管 HOSE BORE		管子外径	尺寸 DIMENSIONS		
	THREAD T	公称内径DN	标号 DASH	TUBE O. D	L		S1
Q20513-36-12T	M36X2	19	12	25	33.5		46
Q20513-42-16T	M42X2	25	16	30	37.5		50
Q20513-52-20T	M52X2	32	20	38	45.5		60

Q20543-T

45°公制内螺纹24°锥 带O型圈重系列

45°Metric Female 24° Cone O-Ring H.T. ISO 12151-2-DIN 3865

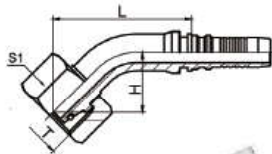

代号 PART NO.	螺纹T	软管 HOSE BORE		管子外径	尺寸 DIMENSIONS		
	THREAD T	公称内径DN	标号 DASH	TUBE O. D	L	H	S1
Q20543-36-12T	M36X2	19	12	25	80.2	30.5	46
Q20543-42-16T	M42X2	25	16	30	85.4	35.5	50
Q20543-52-20T	M52X2	32	20	38	110.75	42	60

Q20593-T

90°公制内螺纹24°锥 带O型圈重系列

90°Metric Female 24° Cone O-Ring H.T. ISO 12151-2-DIN 3865

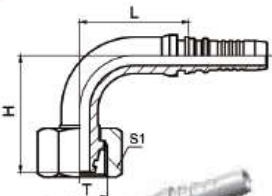

代号 PART NO.	螺纹T	软管 HOSE BORE		管子外径	尺寸 DIMENSIONS		
	THREAD T	公称内径DN	标号 DASH	TUBE O. D	L	H	S1
Q20593-36-12T	M36X2	19	12	25	69	59	46
Q20593-42-16T	M42X2	25	16	30	74.5	70	50
Q20593-50-20T	M52X2	32	20	38	99.5	87	60

Q22613-OR

英管内螺纹60°外锥面带O型圈
BSP Female 60°O-Ring Cone ISO 12151-6

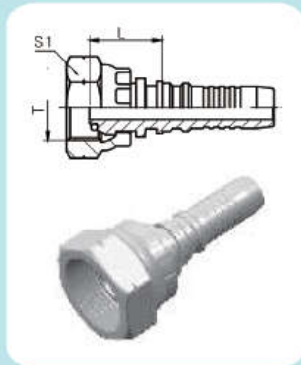

代号 PART NO.	螺纹T THREAD T	软管 HOSE BORE		尺寸 DIMENSIONS			
		公称内径DN	标号 DASH	L			S1
Q22613-12-12OR	G3/4"X14	19	12	26.5			32
Q22613-16-16OR	G1"X11	25	16	30.4			41
Q22613-20-20OR	G1.1/4"X11	32	20	35.8			50
Q22613-24-24OR	G1.1/2"X11	38	24	36.7			55

Q22643-OR

45°英管内螺纹60°外锥面 带O型圈
45°BSP Female 60°O-Ring Cone ISO 12151-6



代号 PART NO.	螺纹T THREAD T	软管 HOSE BORE		尺寸 DIMENSIONS			
		公称内径DN	标号 DASH	L	H		S1
Q22643-12-12OR	G3/4"X14	19	12	78.7	29		32
Q22643-16-16OR	G1"X11	25	16	84.9	35		41
Q26443-20-20OR	G1.1/4"X11	32	20	108.8	40		50
Q26443-24-24OR	G1.1/2"X11	38	24	123.1	50		55

Q22693-OR

90°英管内螺纹60°外锥面 带O型圈
90°BSP Female 60°O-Ring Cone ISO 12151-6

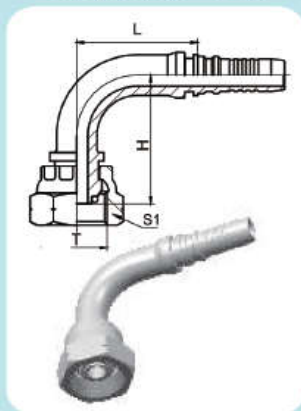

代号 PART NO.	螺纹T THREAD T	软管 HOSE BORE		尺寸 DIMENSIONS			
		公称内径DN	标号 DASH	L	H		S1
Q22693-12-12OR	G3/4"X14	19	12	69	58		32
Q22693-16-16OR	G1"X11	25	16	74.5	70		41
Q22693-20-20OR	G1.1/4"X11	32	20	99.5	85		50
Q22693-24-24OR	G1.1/2"X11	38	24	110	100		55

Q26713

美制JIC内螺纹74°内锥面

JIC Female 74° Cone Seat ISO 12151-5 -SAE J514

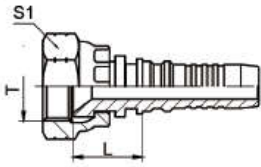

代号 PART NO.	螺纹T	软管 HOSE BORE		尺寸 DIMENSIONS		
	THREAD T	公称内径DN	标号 DASH	L		S1
Q26713-12-12	1.1/16" X12	19	12	26.5		32
Q26713-16-16	1.5/16" X12	25	16	29.4		41
Q26713-20-20	1.5/8" X12	32	20	32.3		50
Q26713-24-24	1.7/8" X12	38	24	35.2		60
QS26713-32-32	2.1/2" X12	50	32	34.5		75

Q26743

45° 美制JIC内螺纹74°内锥面

45° JIC Female 74° Cone Seat ISO 12151-5 -SAE J514

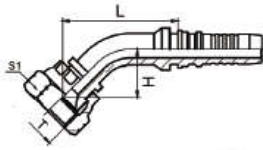

代号 PART NO.	螺纹T	软管 HOSE BORE		尺寸 DIMENSIONS		
	THREAD T	公称内径DN	标号 DASH	L	H	S1
Q26743-12-12	1.1/16" X12	19	12	70.7	21	32
Q26743-16-16	1.5/16" X12	25	16	73.9	24	41
Q26743-20-20	1.5/8" X12	32	20	100.8	32	50
Q26743-24-24	1.7/8" X12	38	24	115.1	42	60
Q26743-32-32	2.1/2" X12	51	32	136	51.5	75

Q26793

90° 美制JIC内螺纹74°内锥面

90° JIC Female 74° Cone Seat ISO 12151-5 -SAE J514

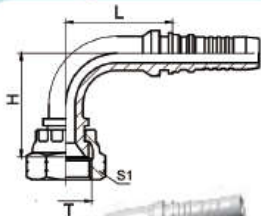

代号 PART NO.	螺纹T	软管 HOSE BORE		尺寸 DIMENSIONS		
	THREAD T	公称内径DN	标号 DASH	L	H	S1
Q26793-12-12	1.1/16" X12	19	12	69	58	32
Q26793-16-16	1.5/16" X12	25	16	74.5	71	41
Q26793-20-20	1.5/8" X12	32	20	99.5	78	50
Q26793-24-24	1.7/8" X12	38	24	110	86	60
Q26793-32-32	2.1/2" X12	50	32	133.3	140	75

Q14213

美制ORFS外螺纹平面O型圈密封
ORFS Male O-Ring Seal ISO 12151-1 -SAE J1453

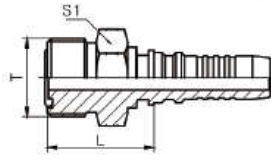

代号 PART NO.	螺纹T THREAD T	软管 HOSE BORE		尺寸 DIMENSIONS			
		公称内径DN	标号 DASH	L			S1
Q14213-12-12	1.3/16 " X12	19	12	38.5			32
Q14213-16-16	1.7/16 " X12	25	16	40.5			38
Q14213-20-20	1.11/16 " X12	32	20	42.5			46
Q14213-24-24	2 " X12	24	24	45.5			55

Q24213

美制ORFS内螺纹平面
ORFS Female Flat Seat ISO 12151-1- SAE J516

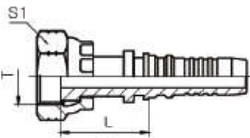

代号 PART NO.	螺纹T THREAD T	软管 HOSE BORE		尺寸 DIMENSIONS			
		公称内径DN	标号 DASH	L			S1
Q24213-12-12	1.3/16 " X12	19	12	41			36
Q24213-16-16	1.7/16 " X12	25	16	44.4			41
Q24213-20-20	1.11/16 " X12	32	20	47.8			50
Q24213-24-24	2 " X12	38	24	48.2			60

Q24243

45°美制ORFS内螺纹平面
45°Elbow ORFS Female Flat Seat ISO 12151-1- SAE J516

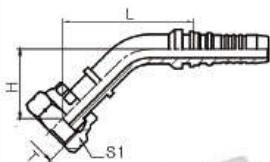

代号 PART NO.	螺纹T THREAD T	软管 HOSE BORE		尺寸 DIMENSIONS			
		公称内径DN	标号 DASH	L	H		S1
Q 24243-12-12	1.3/16 " X12	19	12	70.7	21		36
Q 24243-16-16	1.7/16 " X12	25	16	73.9	24		41
Q 24243-20-20	1.11/16 " X12	32	20	100.8	32		50
Q 24243-24-24	2 " X12	38	24	115.1	42		60

Q24293

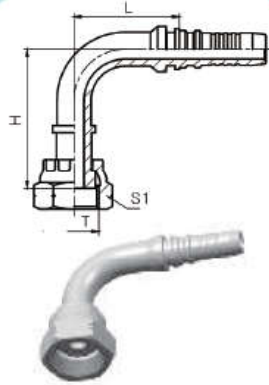

90° 美制ORFS内螺纹平面
90° Elbow ORFS Female Flat Seat ISO 12151-1- SAE J516

代号 PART NO.	螺纹T	软管 HOSE BORE		尺寸 DIMENSIONS		
	THREAD T	公称内径DN	标号 DASH	L	H	S1
Q24293-12-12	1.3/16" X12	19	12	69	58	36
Q24293-16-16	1.7/16" X12	25	16	74.5	71	41
Q24293-20-20	1.11/16" X12	32	20	99.5	78	50
Q24293-24-24	2" X12	38	24	110	86	60

Q87313

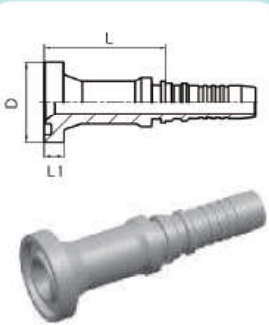

SAE法兰 3000PSI 61型
SAE Flange 3000 PSI Code 61
ISO 12151-3- SAE J516

代号 PART NO.	法兰型号	软管 HOSE BORE		尺寸 DIMENSIONS		
	FLANGE SIZE	公称内径DN	标号 DASH	L	D	L1
Q87313-12-12	3/4"	19	12	50	38.1	6.73
Q87313-16-12	1"	19	12	53	44.4	8
Q87313-16-16	1"	25	16	54	44.4	8
Q87313-20-16	1.1/4"	25	16	59	50.8	8
Q87313-20-20	1.1/4"	32	20	60	50.8	8
Q87313-24-20	1.1/2"	32	20	70	60.3	8
Q87313-24-24	1.1/2"	38	24	70	60.3	8
Q87313-32-24	2"	38	24	67.5	71.4	9.53
Q87313-32-32	2"	51	32	64.5	71.4	9.53

Q87343

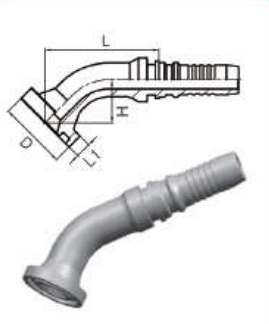

45° 弯 SAE法兰 3000PSI 61型
45° SAE Flange 3000 PSI Code 61
ISO 12151-3- SAE J516

代号 PART NO.	法兰型号	软管 HOSE BORE		尺寸 DIMENSIONS			
	FLANGE SIZE	公称内径DN	标号 DASH	L	H	D	L1
Q87343-12-12	3/4"	19	12	75.7	26	38.1	6.73
Q87343-16-12	1"	19	12	81.7	32	44.4	8
Q87343-16-16	1"	25	16	81.9	32	44.4	8
Q87343-20-16	1.1/4"	25	16	87.9	38	50.8	8
Q87343-20-20	1.1/4"	32	20	106.8	38	50.8	8
Q87343-24-20	1.1/2"	32	20	112.8	44	60.3	8
Q87343-24-24	1.1/2"	38	24	117.1	44	60.3	8
Q87343-32-24	2"	38	24	129.1	56	71.4	9.53
Q87343-32-32	2"	51	32	140.5	56	71.4	9.53

Q87393

90°SAE法兰 3000 PSI 61型

90°SAE Flange 3000 PSI Code 61 ISO 12151-3-SAE J516

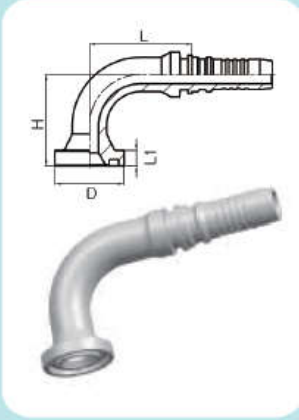

代号 PART NO.	法兰型号	软管 HOSE BORE		尺寸 DIMENSIONS			
	FLANGE SIZE	公称内径DN	标号 DASH	L	H	D	L1
Q87393-12-12	3/4"	19	12	69	58	38.1	6.73
Q87393-16-12	1"	19	12	69	70	44.4	8
Q87393-16-16	1"	25	16	74.5	70	44.4	8
Q87393-20-16	1.1/4"	25	16	74.5	90	50.8	8
Q87393-20-20	1.1/4"	32	20	99.5	90	50.8	8
Q87393-24-20	1.1/2"	32	20	99.5	104	60.3	8
Q87393-24-24	1.1/2"	38	24	110	104	60.3	8
Q87393-32-24	2"	38	24	110	138	71.4	9.53
Q87393-32-32	2"	51	32	133.3	138	71.4	9.53

Q87613

SAE法兰 6000 PSI 62型

SAE Flange 6000 PSI Code 62 ISO 12151-3-SAE J516

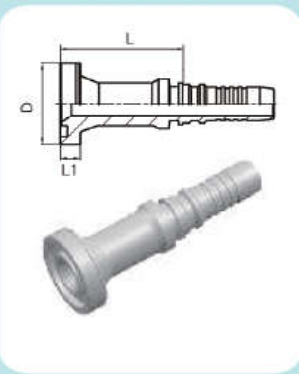

代号 PART NO.	法兰型号	软管 HOSE BORE		尺寸 DIMENSIONS		
	FLANGE SIZE	公称内径DN	标号 DASH	L	D	L1
Q87613-12-12	3/4"	19	12	52.5	41.3	8.76
Q87613-16-12	1"	19	12	55.5	47.6	9.53
Q87613-16-16	1"	25	16	58.5	47.6	9.53
Q87613-20-16	1.1/4"	25	16	66	54	10.29
Q87613-20-20	1.1/4"	32	20	67.5	54	10.29
Q87613-24-20	1.1/2"	32	20	76	63.5	12.57
Q87613-24-24	1.1/2"	38	24	77	63.5	12.57
Q87613-32-24	2"	38	24	84	79.4	12.57
Q87613-32-32	2"	51	32	84	79.4	12.57

Q87643

45°SAE法兰 6000 PSI 62型

45°SAE Flange 6000 PSI Code 62 ISO 12151-3-SAE J516

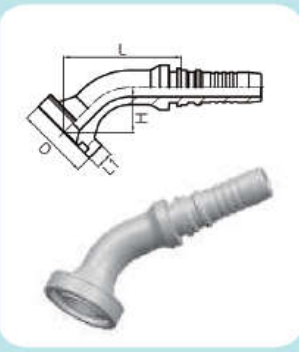

代号 PART NO.	法兰型号	软管 HOSE BORE		尺寸 DIMENSIONS			
	FLANGE SIZE	公称内径DN	标号 DASH	L	H	D	L1
Q87643-12-12	3/4"	19	12	75.7	26	41.3	8.76
Q87643-16-12	1"	19	12	81.7	32	47.6	9.53
Q87643-16-16	1"	25	16	81.9	32	47.6	9.53
Q87643-20-16	1.1/4"	25	16	87.9	38	54	10.29
Q87643-20-20	1.1/4"	32	20	106.8	38	54	10.29
Q87643-24-20	1.1/2"	32	20	112.8	44	63.5	12.57
Q87643-24-24	1.1/2"	38	24	117.1	44	63.5	12.57
Q87643-32-24	2"	38	24	129.1	56	79.4	12.57
Q87643-32-32	2"	51	32	140.5	56	79.4	12.57

Q87693

90°SAE法兰 6000 PSI 62型

90°SAE Flange 6000 PSI Code 62 ISO 12151-3-SAE J516

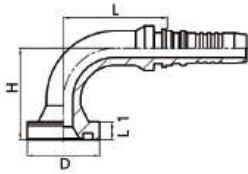

代号 PART NO.	法兰型号	软管 HOSE BORE		尺寸 DIMENSIONS			
	FLANGE SIZE	公称内径DN	标号 DASH	L	H	D	L1
Q87693-12-12	3/4"	19	12	69	58	41.3	8.76
Q87693-16-12	1"	19	12	69	70	47.6	9.53
Q87693-16-16	1"	25	16	74.5	70	47.6	9.53
Q87693-20-16	1.1/4"	25	16	74.5	90	54	10.29
Q87693-20-20	1.1/4"	32	20	99.5	90	54	10.29
Q87693-24-20	1.1/2"	32	20	99.5	104	63.5	12.57
Q87693-24-24	1.1/2"	38	24	110	104	63.5	12.57
Q87693-32-24	2"	38	24	110	138	79.4	12.57
Q87693-32-32	2"	51	32	133.3	138	79.4	12.57

Q87913

SAE法兰 9000 PSI
SAE Flange 9000 PSI

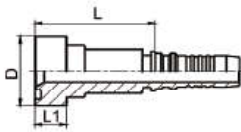

代号 PART NO.	法兰型号	软管 HOSE BORE		尺寸 DIMENSIONS		
	FLANGE SIZE	公称内径DN	标号 DASH	L	D	L1
Q87913-12-12	3/4"	19	12	58	41.3	14.3
Q87913-16-12	1"	19	12	62.5	47.6	14.3
Q87913-16-16	1"	25	16	63.5	47.6	14.3
Q87913-20-16	1.1/4"	25	16	70.5	54	14.3
Q87913-20-20	1.1/4"	32	20	71.5	54	14.3
Q87913-24-20	1.1/2"	32	20	78.5	63.5	14.3
Q87913-24-24	1.1/2"	38	24	79	63.5	14.3

Q87943

45°SAE法兰 9000 PSI
45°SAE Flange 9000 PSI

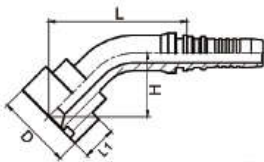

代号 PART NO.	法兰型号	软管 HOSE BORE		尺寸 DIMENSIONS			
	FLANGE SIZE	公称内径DN	标号 DASH	L	H	D	L1
Q87943-12-12	3/4"	19	12	80	35	41.3	14.3
Q87943-16-12	1"	19	12	81.5	36.5	47.6	14.3
Q87943-16-16	1"	25	16	93	38	47.6	14.3
Q87943-20-16	1.1/4"	25	16	95.5	40	54	14.3
Q87943-20-20	1.1/4"	32	20	109	44.5	54	14.3
Q87943-24-20	1.1/2"	32	20	111	46.5	63.5	14.3
Q87943-24-24	1.1/2"	38	24	127	51.5	63.5	14.3

Q87993

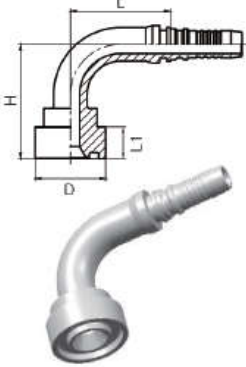
90°SAE法兰 9000 PSI
90°SAE Flange 9000 PSI

代号 PART NO.	法兰型号 FLANGE SIZE	软管 HOSE BORE		尺寸 DIMENSIONS			
		公称内径DN	标号 DASH	L	H	D	L1
Q87993-12-12	3/4"	19	12	71	69	41.3	14.3
Q87993-16-12	1"	19	12	71	71	47.6	14.3
Q87993-16-16	1"	25	16	82	78	47.6	14.3
Q87993-20-16	1.1/4"	25	16	82	81	54	14.3
Q87993-20-20	1.1/4"	32	20	99.5	93.5	54	14.3
Q87993-24-20	1.1/2"	32	20	99.5	96.5	63.5	14.3
Q87993-24-24	1.1/2"	38	24	118	106	63.5	14.3

Q00518

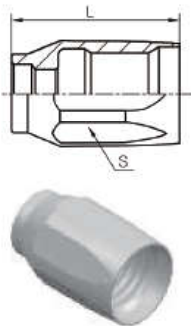
SAE 100 R5 软管可拆式套筒
Ferrule For SAE 100 R5 Hose

代号 PART NO.	软管 HOSE BORE		尺寸 DIMENSIONS	
		标号 DASH	L	S
Q00518-04		04	28	17
Q00518-05		05	30.5	19
Q00518-06		06	33	22
Q00518-08		08	42	24
Q00518-10		10	45.5	30
Q00518-12		12	53.5	32
Q00518-16		16	42	36
Q00518-20		20	44.5	46
Q00518-24		24	47	50
Q00518-32		32	57	65

Q12618-R5

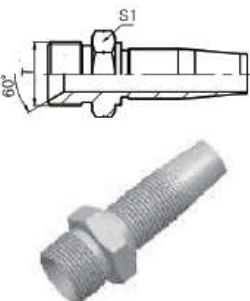
英制外螺纹60°内锥面
Male 60° Cone Seat

代号 PART NO.	螺纹 T THREAD T	软管 HOSE BORE		尺寸 DIMENSIONS	
		公称内径 DN	标号 DASH		S1
Q12618-04-04(R5)	G1/4"X19	5	4		14
Q12618-06-05(R5)	G3/8"X19	6	5		17
Q12618-06-06(R5)	G3/8"X19	8	6		17
Q12618-08-08(R5)	G1/2"X14	11	8		22
Q12618-10-10(R5)	G5/8"X14	13	10		24
Q12618-12-12(R5)	G3/4"X14	16	12		27
Q12618-16-16(R5)	G1"X11	22	16		36
Q12618-20-20(R5)	G1.1/4"X11	28	20		46
Q12618-24-24(R5)	G1.1/2"X11	35	24		50
Q12618-32-32(R5)	G2"X11	46	32		60

Q15618-R5

美制布锥管螺纹
NPT Male

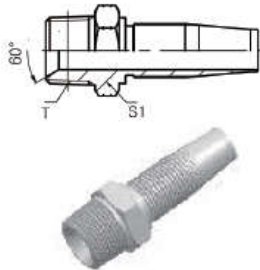

代号 PART NO.	螺纹 T THREAD T	软管 HOSE BORE		尺寸 DIMENSIONS		
			标号 DASH			S1
Q15618-02-04(R5)	Z1/8"X27		04			12
Q15618-04-04(R5)	Z1/4"X18		04			17
Q15618-04-06(R5)	Z1/4"X18		06			17
Q15618-06-05(R5)	Z3/8"X18		05			19
Q15618-06-06(R5)	Z3/8"X18		06			19
Q15618-08-08(R5)	Z1/2"X14		08			22
Q15618-12-10(R5)	Z3/4"X14		10			30
Q15618-12-12(R5)	Z3/4"X14		12			30
Q15618-16-16(R5)	Z1"X11.5		16			36
Q15618-20-20(R5)	Z1.1/4"X11.5		20			46
Q15618-24-24(R5)	Z1.1/2"X11.5		24			50
Q15618-32-32(R5)	Z2"X11.5		32			65

Q16718-R5

美制 JIC 外螺纹 74°外锥面
JIC Male 74° Cone

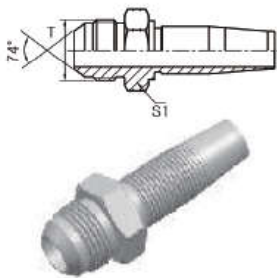

代号 PART NO.	螺纹 T THREAD T	软管 HOSE BORE		尺寸 DIMENSIONS		
			标号 DASH			S1
Q16718-04-04(R5)	7/16"X20		04			12
Q16718-06-05(R5)	9/16"X18		05			17
Q16718-06-06(R5)	9/16"X18		06			17
Q16718-08-06(R5)	3/4"X16		06			22
Q16718-08-08(R5)	3/4"X16		08			22
Q16718-10-10(R5)	7/8"X14		10			24
Q16718-12-12(R5)	1.1/16"X12		12			30
Q16718-16-16(R5)	1.5/16"X12		16			36
Q16718-20-20(R5)	1.5/8"X12		20			46
Q16718-24-24(R5)	1.7/8"X12		24			50

Q17818-R5

美制 SAE 外螺纹 90°外锥面
SAE Male 90° Cone

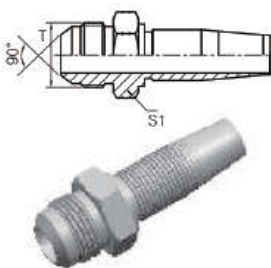

代号 PART NO.	螺纹 T THREAD T	软管 HOSE BORE		尺寸 DIMENSIONS		
			标号 DASH			S1
Q17818-06-06(R5)	7/16"X20		06			17
Q17818-08-08(R5)	9/16"X18		08			22
Q17818-12-12(R5)	9/16"X18		12			30

Q20418D-R5

公制内螺纹24°锥带O型圈轻系列
METRIC Female 24° Cone O-ring L.T.

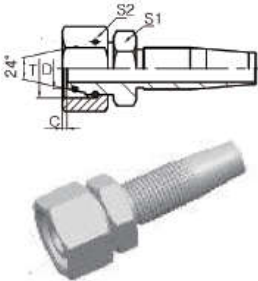

代号 PART NO.	螺纹 T THREAD T	软管 HOSE BORE		管子外径 D TUBE O.D	尺寸 DIMENSIONS		
		公称内径 DN	标号 DASH		C	S1	S2
Q20418D-14-04(R5)	M14X1.5	5	4	8	1.4	12	17
Q20418D-16-05(R5)	M16X1.5	6	5	10	2.1	14	19
Q20418D-18-06(R5)	M18X1.5	8	6	12	1.8	17	22
Q20418D-22-08(R5)	M22X4.5	11	8	15	3	19	27
Q20418D-26-10(R5)	M26X1.5	13	10	18	2.1	27	32
Q20418D-30-12(R5)	M30X2	16	12	22	3.8	30	36
Q20418D-36-16(R5)	M36X2	22	16	28	4.5	36	41
Q20418D-45-16(R5)	M45X2	22	16	35	4	41	50
Q20418D-45-20(R5)	M45X2	28	20	35	4	41	50
Q20418D-52-24(R5)	M52X2	35	24	42	4	50	60

Q20518-R5

公制内螺纹24°锥带O型圈重系列
METRIC Female 24° Cone O-ring H.T.

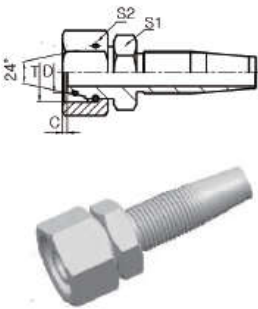

代号 PART NO.	螺纹 T THREAD T	软管 HOSE BORE		管子外径 D TUBE O.D	尺寸 DIMENSIONS		
		公称内径 DN	标号 DASH		C	S1	S2
Q20518D-16-04(R5)	M14X1.5	5	04	8	1.8	14	19
Q20518D-16-05(R5)	M16X1.5	6	05	8	1.8	14	19
Q20518D-18-04(R5)	M18X1.5	5	04	10	1.5	17	22
Q20518D-18-06(R5)	M18X1.5	8	06	10	1.5	17	22
Q20518D-20-06(R5)	M20X1.5	8	06	12	2.5	17	24
Q20518D-22-06(R5)	M22X1.5	8	06	14	3	19	27
Q20518D-24-08(R5)	M24X1.5	11	08	16	3	22	30
Q20518D-30-10(R5)	M30X2	13	10	20	2.5	27	36
Q20518D-30-12(R5)	M30X2	16	12	20	2.5	27	36
Q20518D-36-12(R5)	M36X2	16	12	25	3.2	36	41
Q20518D-36-16(R5)	M36X2	22	16	25	3.2	36	41
Q20518D-42-16(R5)	M42X2	22	16	30	3.9	41	50
Q20518D-42-20(R5)	M42X2	28	20	30	3.9	41	50
Q20518D-52-20(R5)	M52X2	28	20	38	4.5	50	60
Q20518D-52-24(R5)	M52X2	35	24	38	4.5	50	60

Q21698D-R5

90°美制 NPSM 内螺纹 60°外锥面
90°NPSM Female 60° Cone

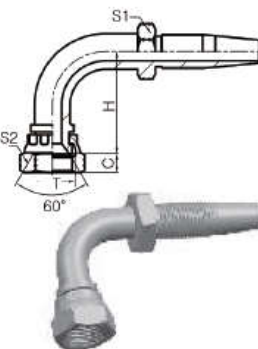

代号 PART NO.	螺纹 T THREAD T	软管 HOSE BORE		尺寸 DIMENSIONS			
		公称内径 DN	标号 DASH	B	H	S1	S2
Q21698D-04-04(R5)	1/4"X18	6	04	4.6	40.5	14	19
Q21698D-06-05(R5)	3/8"X18	8	05	6	43	14	22
Q21698D-06-06(R5)	3/8"X18	10	06	6	45.3	17	22
Q21698D-08-08(R5)	1/2"X14	12	08	7.5	53.2	19	27
Q21698D-12-10(R5)	3/4"X14	16	10	8.9	53.5	24	32
Q21698D-12-12(R5)	3/4"X14	20	12	8.9	69.1	27	32
Q21698D-16-16(R5)	1"X11.5	25	16	10.5	75	32	41
Q21698D-20-20(R5)	1.1/4"X11.5	32	20	11.2	86	41	50
Q21698D-24-24(R5)	1.1/2"X11.5	40	24	11.2	101.5	46	55
Q21698D-32-32(R5)	2"X11.5	50	32	11.2	124.5	65	70

Q22618D-R5

英制内螺纹 60°外锥面
BSP Female 60° Cone

代号 PART NO.	螺纹 T THREAD T	软管 HOSE BORE		尺寸 DIMENSIONS			
			标号 DASH		C	S1	S2
Q22618D-04-04(R5)	G1/4"X19		04		5.5	14	19
Q22618D-06-05(R5)	G3/8"X19		05		6.3	17	22
Q22618D-06-06(R5)	G3/8"X19		06		6.3	17	22
Q22618D-08-08(R5)	G1/2"X14		08		7.5	19	27
Q22618D-10-10(R5)	G5/8"X14		10		9.5	22	30
Q22618D-12-12(R5)	G3/4"X14		12		10.9	27	32
Q22618D-16-16(R5)	G1"X11		16		11.7	32	41
Q22618D-20-20(R5)	G1.1/4"X11		20		11	41	50

Q24218D-R5

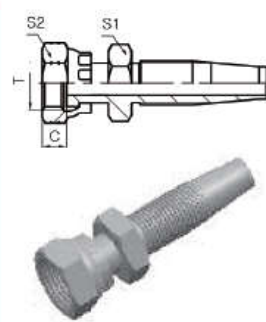
美制ORFS内螺纹平面双六角
ORFS Female Flat Double Hexagon

代号 PART NO.	螺纹 T THREAD T	软管 HOSE BORE		尺寸 DIMENSIONS			
			标号 DASH		C	S1	S2
Q24218D-04-04(R5)	9/16"X18		04		8.5	14	19
Q24218D-04-05(R5)	9/16"X18		05		8.5	14	19
Q24218D-06-06(R5)	11/16"X16		06		10	17	22
Q24218D-08-08(R5)	13/16"X16		08		11	19	27
Q24218D-10-10(R5)	1"X14		10		13.5	24	30
Q24218D-12-12(R5)	1.3/16"X12		12		15	30	36
Q24218D-16-16(R5)	1.7/16"X12		16		15	36	41
Q24218D-20-20(R5)	1.11/16"X12		20		15	41	50
Q24218D-24-24(R5)	2"X12		24		16	50	60

Q26718D-R5

美制 JIC 内螺纹 74°内锥面
JIC Female 74° Cone Seat

代号 PART NO.	螺纹 T THREAD T	软管 HOSE BORE		尺寸 DIMENSIONS			
			标号 DASH		C	S1	S2
Q26718D-04-04(R5)	7/16"X20		04		9	14	15
Q26718D-05-05(R5)	1/2"X20		05		9.5	14	17
Q26718D-06-06(R5)	9/16"X18		06		10.5	17	19
Q26718D-08-08(R5)	3/4"X16		08		11	22	24
Q26718D-10-10(R5)	7/8"X14		10		13	27	27
Q26718D-12-12(R5)	1.1/16"X12		12		15	32	32
Q26718D-16-16(R5)	1.5/16"X12		16		16	38	41
Q26718D-20-20(R5)	1.5/8"X12		20		17	41	50
Q26718D-24-24(R5)	1.7/8"X12		24		20	46	55
Q26718D-32-32(R5)	2.1/2"X12		32		23.5	65	75

Q26798D-R5

90°美制 JIC 内螺纹 74°内锥面
90°JIC Female 74° Cone Seat

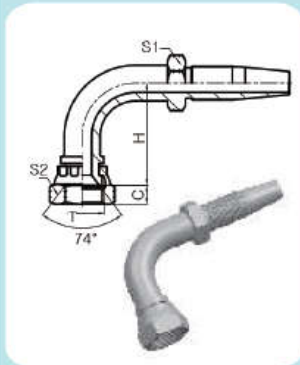

代号 PART NO.	螺纹 T THREAD T	软管 HOSE BORE		尺寸 DIMENSIONS			
		标号 DASH		C	H	S1	S2
Q26798D-04-04(R5)	7/16"X20	04		9	33.5	14	15
Q26798D-05-05(R5)	1/2"X20	05		9.5	37	14	17
Q26798D-06-06(R5)	9/16"X18	06		10.5	39.3	17	19
Q26798D-08-08(R5)	3/4"X16	08		11	47.5	19	24
Q26798D-10-10(R5)	7/8"X14	10		13	52.5	24	27
Q26798D-12-12(R5)	1.1/16"X12	12		15	63.5	27	32
Q26798D-16-16(R5)	1.5/16"X12	16		16	70	32	41
Q26798D-20-20(R5)	1.5/8"X12	20		17	85	41	50
Q26798D-24-24(R5)	1.7/8"X12	24		20	97.5	46	55
Q26798D-32-32(R5)	2.1/2"X12	32		23.5	118.8	65	75

Q27818D-R5

美制SAE 内螺纹 90°内锥面
SAE Female 90° Cone Seat

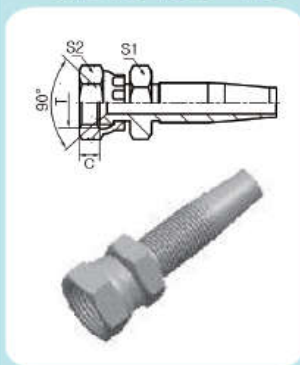

代号 PART NO.	螺纹 T THREAD T	软管 HOSE BORE		尺寸 DIMENSIONS			
		标号 DASH		C	S1	S2	
Q27818D-04-04(R5)	7/16"X20	04		9	14	15	
Q27818D-05-05(R5)	1/2"X20	05		9	14	17	
Q27818D-06-06(R5)	5/8"X18	06		11.3	17	22	
Q27818D-08-08(R5)	3/4"X16	08		11	22	24	
Q27818D-10-10(R5)	7/8"X14	10		13	27	27	
Q27818D-12-12(R5)	1.1/16"X14	12		14.3	32	32	

Q27898D-R5

90°美制 SAE 内螺纹 90°内锥面
90°SAE Female 90° Cone Seat

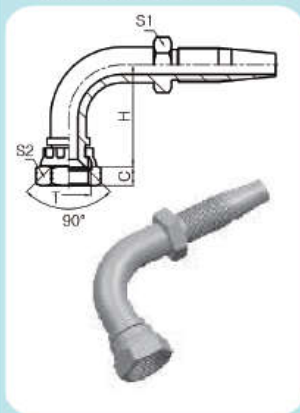

代号 PART NO.	螺纹 T THREAD T	软管 HOSE BORE		尺寸 DIMENSIONS			
		公称内径 DN	标号 DASH	C	H	S1	S2
Q27898D-06-06(R5)	5/8"X18	10	06	11.3	40.8	17	22
Q27898D-08-08(R5)	3/4"X16	12	08	10.5	47.5	19	24