

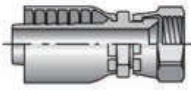









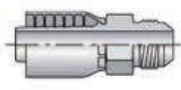

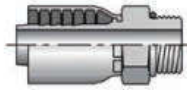
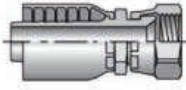



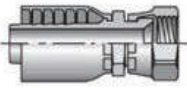

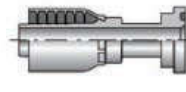

# 43 SERIES INDEX ONE PIECE TYPE CRIMP HOSE FITTING

<p>SS-43-FJX</p>  <p>37° Flare JIC Female Swivel</p> <p>P17</p>	<p>SS-43-FJX45</p>  <p>37° Flare JIC Female Swivel, 45°</p> <p>P18</p>	<p>SS-43-FJX90</p>  <p>37° Flare JIC Female Swivel, 90°</p> <p>P19</p>	<p>SS-43-MJ</p>  <p>37° Flare JIC Male Rigid</p> <p>P20</p>	<p>SS-43-FPX</p>  <p>NPT Female Swivel</p> <p>P20</p>
<p>SS-43-MP</p>  <p>Pipe Male Rigid</p> <p>P21</p>	<p>SS-43-MOR</p>  <p>O-Ring Boss Rigid (ORB) - Stainless</p> <p>P22</p>	<p>SS-43-FFX</p>  <p>O-Ring Face Seal (ORFS) Female Swivel</p> <p>P22</p>	<p>SS-43-FFX45</p>  <p>O-Ring Face Seal (ORFS) Female Swivel, 45°</p> <p>P23</p>	<p>SS-43-FFX90</p>  <p>O-Ring Face Seal (ORFS) Female Swivel, 90°</p> <p>P24</p>
<p>SS-43-MFF</p>  <p>O-Ring Face Seal (ORFS) Male Rigid - Stainless</p> <p>P25</p>	<p>SS-43-FBX</p>  <p>BSP Female Swivel - Stainless</p> <p>P25</p>	<p>SS-43-FBX45</p>  <p>BSP 45° Female Swivel Elbow - Stainless</p> <p>P26</p>	<p>SS-43-FBX90</p>  <p>BSP Female Swivel, 90° Elbow - Stainless</p> <p>P26</p>	<p>SS-43-FL61</p>  <p>Code 61 Flange Rigid</p> <p>P27</p>
<p>SS-43-FL6145</p>  <p>Code 61 Flange Rigid, 45°</p> <p>P27</p>	<p>SS-43-FL6190</p>  <p>Code 61 Flange Rigid, 90°</p> <p>P28</p>	<p>SS-43-FL62</p>  <p>Code 62 Flange Rigid</p> <p>P28</p>	<p>SS-43-FL6245</p>  <p>Code 62 Flange Rigid, 45°</p> <p>P29</p>	<p>SS-43-FL6290</p>  <p>Code 62 Flange Rigid, 90°</p> <p>P29</p>
<p>SS-43-FDL</p>  <p>Metric DIN Light</p> <p>P30</p>	<p>SS-43-FDL45</p>  <p>Metric DIN Light, 45°</p> <p>P30</p>	<p>SS-43-FDL90</p>  <p>Metric DIN Light, 90°</p> <p>P31</p>	<p>SS-43-MDL</p>  <p>Male Metric DIN Light</p> <p>P31</p>	<p>SS-43-FDS45</p>  <p>Metric DIN Heavy, 45°</p> <p>P32</p>
<p>SS-43-FDS90</p>  <p>Metric DIN Heavy, 90°</p> <p>P32</p>	<p>SS-43-FDS</p>  <p>Metric DIN Heavy</p> <p>P33</p>	<p>SS-43-MDS</p>  <p>Male Metric DIN Heavy</p> <p>P33</p>		

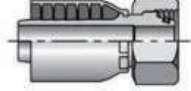
# 43 SERIES

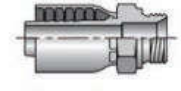

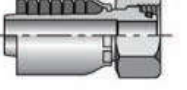
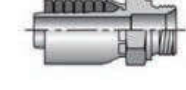
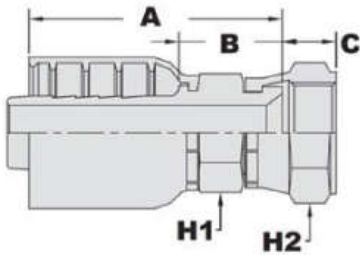
**Product Number:** SS-43-FJX

**Name:** 37° Flare JIC Female Swivel

**Material:** 316 Stainless Steel

**Uses:** 1 & 2 Braided Hose

**Hoses:** 1SN (100R1), 2SN (100R2), R16, R17

PART NUMBER	HOSE I.D. (INCHES)	THREAD	DIMENSIONS (INCHES)			H1	H2
			A	B	C		
SS-43-FJX-04-04	1/4	7/16 -20	1.61	0.83	0.34	0.56	0.56
SS-43-FJX-04-05	1/4	1/2 -20	1.65	0.87	0.37	0.56	0.56
SS-43-FJX-04-06	1/4	9/16 -18	1.65	0.87	0.37	0.56	0.69
SS-43-FJX-06-06	3/8	9/16 -18	1.97	0.91	0.37	0.69	0.69
SS-43-FJX-06-08	3/8	3/4 -16	1.97	0.91	0.42	0.69	0.87
SS-43-FJX-08-08	1/2	3/4 -16	2.13	0.91	0.42	0.87	0.87
SS-43-FJX-08-10	1/2	7/8 -14	2.17	0.94	0.50	0.87	1.00
SS-43-FJX-10-10	5/8	7/8 -16	2.48	0.98	0.50	0.87	1.00
SS-43-FJX-10-12	5/8	1-1/16 -12	2.56	1.06	0.56	1.06	1.25
SS-43-FJX-12-12	3/4	1-1/16 -12	2.60	1.06	0.56	1.06	1.25
SS-43-FJX-12-16	3/4	1-5/16 -12	2.60	1.30	0.59	1.06	
SS-43-FJX-16-16	1	1-5/16 -12	3.07	1.30	0.59	1.50	1.37
SS-43-FJX-16-20	1	1-5/8 -12	3.15	1.34	0.63	2.00	2.00
SS-43-FJX-20-20	1.25	1-5/8 -12	3.23	1.38	0.63	2.00	2.00
SS-43-FJX-24-24	1.5	1-7/8 -12	4.02	1.69	0.73	2.25	2.12
SS-43-FJX-32-32	2	2-1/2 -12	4.96	2.17	0.94	2.50	2.87

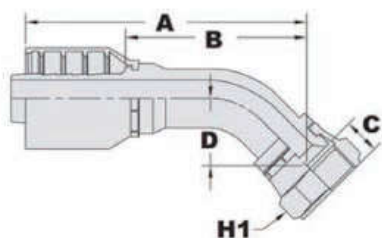

**Product Number:** SS-43-FJX45

**Name:** 37° Flare JIC Female Swivel, 45°

**Material:** 316 Stainless Steel

**Uses:** 1 & 2 Braided Hose

**Hoses:** 1SN (100R1), 2SN (100R2), R16, R17

PART NUMBER	HOSE I.D. (INCHES)	THREAD	DIMENSIONS (INCHES)				H1
			A	B	C	D	
SS-43-FJX90-04-04	1/4	7/16 -20	2.01	1.18	0.34	0.94	0.56
SS-43-FJX90-04-06	1/4	9/16 -18	2.01	1.18	0.37	0.98	0.69
SS-43-FJX90-06-06	3/8	9/16 -18	2.72	1.65	0.37	1.14	0.69
SS-43-FJX90-06-08	3/8	3/4 -16	2.72	1.65	0.42	1.14	0.87
SS-43-FJX90-08-08	1/2	3/4 -16	2.76	1.50	0.42	1.22	0.87
SS-43-FJX90-08-10	1/2	7/8 -14	2.76	1.50	0.50	1.22	1.00
SS-43-FJX90-08-12	1/2	1-1/16-12	2.76	1.50	0.56	1.22	1.25
SS-43-FJX90-10-10	5/8	7/8 -14	2.80	1.65	0.50	1.38	1.00
SS-43-FJX90-12-12	3/4	1-1/16-12	3.98	2.40	0.56	1.97	1.25
SS-43-FJX90-16-16	1	1-5/16-12	4.96	3.19	0.59	2.44	2.50
SS-43-FJX90-20-20	1.25	1-5/8-12	5.51	3.66	0.63	3.23	1.98
SS-43-FJX90-24-24	1.5	1-7/8-12	5.94	3.58	0.73	3.39	2.12
SS-43-FJX90-32-32	2	2-1/2-12	8.11	5.31	0.94	5.28	2.87

# 43 SERIES

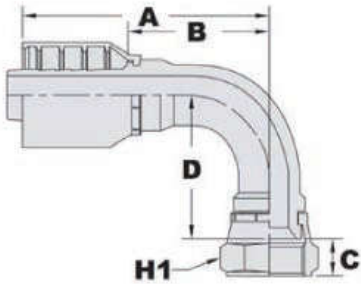

**Product Number:** SS-43-FJX90

**Name:** 37° Flare JIC Female Swivel, 90°

**Material:** 316 Stainless Steel

**Uses:** 1 & 2 Braided Hose

**Hoses:** 1SN (100R1), 2SN (100R2), R16, R17

PART NUMBER	HOSE I.D. (INCHES)	THREAD	DIMENSIONS (INCHES)				H1	L1 1.020
			A	B	C	D		
SS-43-FJX90-04-04	1/4	7/16 -20	2.01	1.18	0.34	0.94	0.56	1.290
SS-43-FJX90-04-06	1/4	9/16 -18	2.01	1.18	0.37	0.98	0.69	1.420
SS-43-FJX90-06-06	3/8	9/16 -18	2.72	1.65	0.37	1.14	0.69	1.480
SS-43-FJX90-06-08	3/8	3/4 -16	2.72	1.65	0.42	1.14	0.87	1.480
SS-43-FJX90-08-08	1/2	3/4 -16	2.76	1.50	0.42	1.22	0.87	1.520
SS-43-FJX90-08-10	1/2	7/8 -14	2.76	1.50	0.50	1.22	1.00	1.780
SS-43-FJX90-08-12	1/2	1-1/16 -12	2.76	1.50	0.56	1.22	1.25	1.750
SS-43-FJX90-10-10	5/8	7/8 -14	2.80	1.65	0.50	1.38	1.00	1.660
SS-43-FJX90-12-12	3/4	1-1/16 -12	3.98	2.40	0.56	1.97	1.25	1.840
SS-43-FJX90-16-16	1	1-5/16 -12	4.96	3.19	0.59	2.44	2.50	1.970
SS-43-FJX90-20-20	1.25	1-5/8 -12	5.51	3.66	0.63	3.23	1.98	1.910
SS-43-FJX90-24-24	1.5	1-7/8 -12	5.94	3.58	0.73	3.39	2.12	1.970
SS-43-FJX90-32-32	2	2-1/2 -12	8.11	5.31	0.94	5.28	2.87	2.180

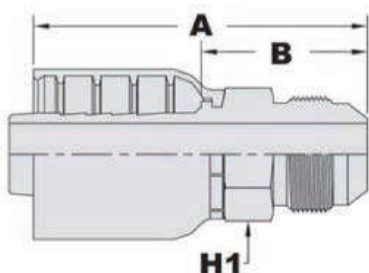

**Product Number:** SS-43-MJ

**Name:** 37° Flare JIC Male Rigid

**Material:** 316 Stainless Steel

**Uses:** 1 & 2 Braided Hose

**Hoses:** 1SN (100R1), 2SN (100R2), R16, R17

PART NUMBER	HOSE I.D. (INCHES)	THREAD	DIMENSIONS (INCHES)		H1
			A	B	
SS-43-MJ-04-04	1/4	7/16 -20	1.81	1.02	0.56
SS-43-MJ-06-06	3/8	9/16 -18	2.13	1.06	0.75
SS-43-MJ-08-08	1/2	3/4 -16	2.40	1.18	0.87
SS-43-MJ-10-10	5/8	7/8 -14	2.80	1.30	0.94
SS-43-MJ-12-12	3/4	1-1/16 -12	3.07	1.54	1.12
SS-43-MJ-16-16	1	1-5/16 -12	3.35	1.57	1.37
SS-43-MJ-20-20	1.25	1-5/8 -12	3.58	1.73	1.87

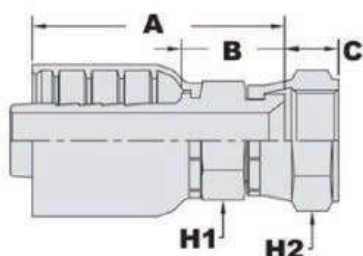

**Product Number:** SS-43-FPX

**Name:** NPT Female Swivel

**Material:** 316 Stainless Steel

**Uses:** 1 & 2 Braided Hose

**Hoses:** 1SN (100R1), 2SN (100R2), R16, R17

PART NUMBER	HOSE I.D. (INCHES)	THREAD	DIMENSIONS (INCHES)			H1	H2
			A	B	C		
SS-43-FPX-04-04	1/4	1/4 -19	1.77	0.98	0.17	0.67	0.75
SS-43-FPX-06-06	3/8	3/8 -19	2.17	1.10	0.24	0.75	0.87
SS-43-FPX-08-08	1/2	1/2 -14	2.36	1.14	0.26	0.87	1.06
SS-43-FPX-10-10	5/8	5/8 -14	2.64	1.14	0.30	1.06	1.06
SS-43-FPX-12-12	3/4	3/4 -14	2.80	1.26	0.35	1.06	1.42
SS-43-FPX-16-16	1	1 -11	3.19	1.42	0.42	1.42	1.61
SS-43-FPX-20-20	1.25	1-1/4 -11	3.66	1.81	0.41	1.81	1.97

# 43 SERIES

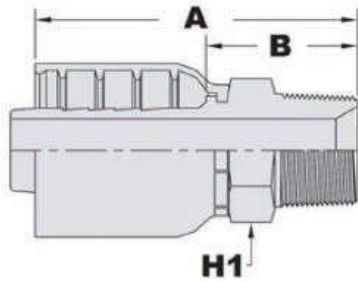

**Product Number:** SS-43-MP

**Name:** Pipe Male Rigid

**Material:** 316 Stainless Steel

**Uses:** 1 & 2 Braided Hose

**Hoses:** 1SN (100R1), 2SN (100R2), R16, R17

PART NUMBER	HOSE I.D. (INCHES)	THREAD	DIMENSIONS (INCHES)		H1
			A	B	
SS-43-MP-04-02	1/4	1/8 -27	1.65	0.85	0.56
SS-43-MP-04-04	1/4	1/4 -18	1.81	1.02	0.56
SS-43-MP-04-06	1/4	3/8 -18	1.93	1.14	0.75
SS-43-MP-06-04	3/8	1/4 -18	2.13	1.06	0.69
SS-43-MP-06-06	3/8	3/8 -18	2.20	1.14	0.69
SS-43-MP-06-08	3/8	1/2 -14	2.32	1.26	0.87
SS-43-MP-08-06	1/2	3/8 -18	2.13	1.06	0.87
SS-43-MP-08-08	1/2	1/2 -14	2.48	1.30	0.87
SS-43-MP-08-12	1/2	3/4 -14	2.48	1.26	1.06
SS-43-MP-10-08	5/8	1/2 -14	2.76	1.30	0.94
SS-43-MP-10-12	5/8	3/4 -14	2.76	1.26	1.06
SS-43-MP-12-12	3/4	3/4 -14	2.91	1.38	1.06
SS-43-MP-12-16	3/4	1 -11.5	3.11	1.57	1.37
SS-43-MP-16-12	1	3/4 -14	3.19	1.42	1.37
SS-43-MP-16-16	1	1 -11.5	3.43	1.61	1.37
SS-43-MP-20-20	1.25	1-1/4 -11.5	3.78	1.93	1.69
SS-43-MP-24-24	1.5	1-1/2 -11.5	4.29	1.97	2.00
SS-43-MP-32-32	2	2 -11.5	5.08	2.28	2.50

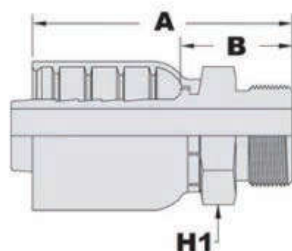

**Product Number:** SS-43-MOR  
**Name:** O-Ring Boss Rigid (ORB) Male - Stainless  
**Material:** 316 Stainless Steel  
**Uses:** 1 & 2 Braided Hose  
**Hoses:** 1SN (100R1), 2SN (100R2), R16, R17

PART NUMBER	HOSE I.D. (INCHES)	THREAD	DIMENSIONS (INCHES)		H1
			A	B	
SS-43-MOR-04-04	1/4	7/16 -20	1.69	0.87	0.56
SS-43-MOR-06-06	3/8	9/16 -18	2.05	0.98	0.69
SS-43-MOR-08-08	1/2	3/4 -16	2.24	0.98	1.06
SS-43-MOR-10-10	5/8	7/8 -14	2.56	1.02	1.00
SS-43-MOR-12-12	3/4	1-1/16 -12	2.76	1.18	1.25
SS-43-MOR-16-16	1	1-5/16 -12	3.07	1.30	1.50

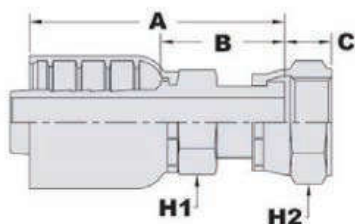

**Product Number:** SS-43-FFX  
**Name:** O-Ring Face Seal (ORFS) Female Swivel  
**Material:** 316 Stainless Steel  
**Uses:** 1 & 2 Braided Hose  
**Hoses:** 1SN (100R1), 2SN (100R2), R16, R17

PART NUMBER	HOSE I.D. (INCHES)	THREAD	DIMENSIONS (INCHES)			H1	TUBE (MM)
			A	B	D		
SS-43-FFX-04-04	1/4"	9/16 -18	1.89	1.10	0.31	0.56	0.69
SS-43-FFX-04-06	1/4	11/16 -16	1.97	1.18	0.35	0.69	0.81
SS-43-FFX-06-06	3/8"	11/16 -16	2.20	1.14	0.35	0.69	0.81
SS-43-FFX-06-08	3/8"	13/16 -16	2.32	1.26	0.43	0.69	0.94
SS-43-FFX-08-08	1/2	13/16 -16	2.48	1.26	0.43	0.81	0.94
SS-43-FFX-08-10	1/2	1 -14	2.76	1.54	0.55	0.81	1.12
SS-43-FFX-08-12	1/2	1-3/16 -12	2.87	1.65	0.59	0.94	1.37
SS-43-FFX-10-10	5/8	1 -14	2.76	1.54	0.55	0.81	1.12
SS-43-FFX-12-12	3/4	1-3/16 -12	3.15	1.61	0.59	1.12	1.37
SS-43-FFX-12-16	3/4	1-7/16 -12	3.23	1.69	0.63	1.25	1.62
SS-43-FFX-16-12	1	1-3/16 -12	3.46	1.69	0.59	1.31	1.37
SS-43-FFX-16-16	1	1-7/16 -12	3.54	1.77	0.63	1.37	1.62
SS-43-FFX-16-20	1	1-11/16 -12	3.07	1.30	0.63	1.37	1.87
SS-43-FFX-20-20	1.25	1-11/16 -12	3.39	1.54	0.63	1.75	1.87
SS-43-FFX-24-24	1.5	2 -12	3.94	1.61	0.63	1.87	2.25

# 43 SERIES

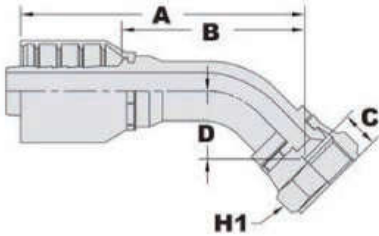

**Product Number:** SS-43-FFX45

**Name:** O-Ring Face Seal (ORFS) Female Swivel, 45°

**Material:** 316 Stainless Steel

**Uses:** 1 & 2 Braided Hose

**Hoses:** 1SN (100R1), 2SN (100R2), R16, R17

PART NUMBER	HOSE I.D. (INCHES)	THREAD	DIMENSIONS (INCHES)				H1
			A	B	C	D	
SS-43-FFX45-04-04	1/4"	9/16 -18	2.17	1.34	0.31	0.51	0.69
SS-43-FFX45-04-06	1/4	11/16 -16	2.20	1.38	0.35	0.55	0.81
SS-43-FFX45-04-08	1/4	13/16 -16	2.28	1.46	0.43	0.63	0.94
SS-43-FFX45-06-06	3/8	11/16 -16	2.68	1.61	0.35	0.63	0.81
SS-43-FFX45-08-08	1/2	13/16 -16	3.23	1.97	0.43	0.83	0.94
SS-43-FFX45-08-10	1/2	1 -14	3.27	2.01	0.55	0.83	1.12
SS-43-FFX45-08-12	1/2	1-3/16 -14	3.23	1.97	0.59	0.79	1.37
SS-43-FFX45-10-10	5/8	1 -14	3.66	2.13	0.55	0.83	1.12
SS-43-FFX45-12-12	3/4	1-3/16 -12	4.53	2.95	0.59	1.10	1.37
SS-43-FFX45-12-16	3/4	1-7/16 -12	4.53	2.95	0.63	1.18	1.62
SS-43-FFX45-16-12	1	1-3/16 -12	4.76	2.99	0.59	1.18	1.37
SS-43-FFX45-16-16	1	1-7/16 -12	4.76	2.99	0.63	1.14	1.62
SS-43-FFX45-16-20	1	1-11/16 -12	4.88	3.11	0.63	1.30	1.87
SS-43-FFX45-20-20	1.25	1-11/16 -12	5.91	4.06	0.63	1.57	1.62
SS-43-FFX45-24-24	1.5	2 -12	6.85	4.49	0.63	1.77	2.25



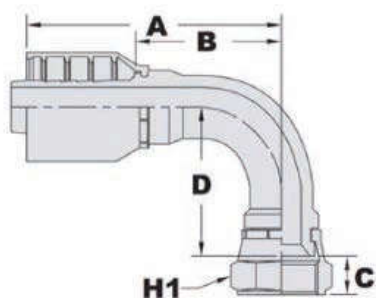

**Product Number:** SS-43-FFX90

**Name:** O-Ring Face Seal (ORFS) Female Swivel, 90°

**Material:** 316 Stainless Steel

**Uses:** 1 & 2 Braided Hose

**Hoses:** 1SN (100R1), 2SN (100R2), R16, R17

PART NUMBER	HOSE I.D. (INCHES)	THREAD	DIMENSIONS (INCHES)				H1
			A	B	C	D	
SS-43-FFX90-04-04	1/4	9/16 -18	2.01	1.18	0.31	0.94	0.69
SS-43-FFX90-04-06	1/4	11/16 -16	2.01	1.18	0.35	1.02	0.81
SS-43-FFX90-06-06	3/8	11/16 -16	2.72	1.65	0.35	1.02	0.81
SS-43-FFX90-06-08	3/8	13/16 -16	2.72	1.65	0.43	1.10	0.94
SS-43-FFX90-08-08	1/2	13/16 -16	2.76	1.50	0.43	1.18	0.94
SS-43-FFX90-08-10	1/2	1 -14	2.76	1.50	0.55	1.22	1.12
SS-43-FFX90-08-12	1/2	1-3/16 -12	2.76	1.50	0.59	1.18	1.37
SS-43-FFX90-10-10	5/8	1 -14	2.80	1.65	0.55	1.50	1.12
SS-43-FFX90-12-12	3/4	1-3/16 -12	3.98	2.40	0.59	1.93	1.37
SS-43-FFX90-12-16	3/4	1-7/16 -12	3.98	2.40	0.63	1.93	1.62
SS-43-FFX90-16-12	1	1-3/16 -12	4.96	3.19	0.59	2.24	1.37
SS-43-FFX90-16-16	1	1-7/16 -12	4.96	3.19	0.63	2.24	1.62
SS-43-FFX90-16-20	1	1-11/16 -12	4.96	3.19	0.63	2.36	1.87
SS-43-FFX90-20-20	1.25	1-11/16 -12	5.51	3.66	0.63	3.03	1.87
SS-43-FFX90-24-24	1.5	2 -12	5.94	3.58	0.63	3.15	2.25

# 43 SERIES

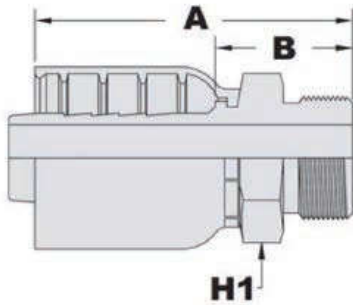

**Product Number:** SS-43-MFF

**Name:** O-Ring Face Seal (ORFS) Male Rigid- Stainless

**Material:** 316 Stainless Steel

**Uses:** 1 & 2 Braided Hose

**Hoses:** 1SN (100R1), 2SN (100R2), R16, R17

PART NUMBER	HOSE I.D. (INCHES)	THREAD	DIMENSIONS (INCHES)		H1
			A	B	
SS-43-MFF-04-04	1/4	7/16 -20	1.69	0.87	0.56
SS-43-MFF-06-06	3/8	9/16 -18	2.05	0.98	0.69
SS-43-MFF-08-08	1/2	3/4 -16	2.24	0.98	1.06
SS-43-MFF-10-10	5/8	7/8 -14	2.56	1.02	1.00
SS-43-MFF-12-12	3/4	1-1/16 -12	2.76	1.18	1.25
SS-43-MFF-16-16	1	1-5/16 -12	3.07	1.30	1.50

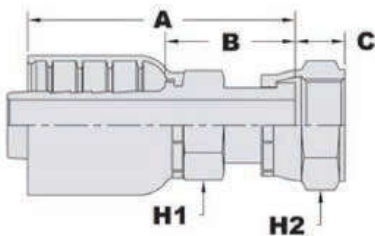

**Product Number:** SS-43-FBX

**Name:** BSPP Female Swivel- Stainless

**Material:** 316 Stainless Steel

**Uses:** 1 & 2 Braided Hose

**Hoses:** 1SN (100R1), 2SN (100R2), R16, R17

PART NUMBER	HOSE I.D. (INCHES)	THREAD	DIMENSIONS (INCHES)			H1	H2
			A	B	C		
SS-43-FBX-04-04	1/4	1/4 -19	1.77	0.98	0.17	0.67	0.75
SS-43-FBX-06-06	3/8	3/8 -19	2.17	1.10	0.24	0.75	0.87
SS-43-FBX-08-08	1/2	1/2 -14	2.36	1.14	0.26	0.87	1.06
SS-43-FBX-10-10	5/8	5/8 -14	2.64	1.14	0.30	1.06	1.06
SS-43-FBX-12-12	3/4	3/4 -14	2.80	1.26	0.35	1.06	1.42
SS-43-FBX-16-16	1	1 -11	3.19	1.42	0.42	1.42	1.61
SS-43-FBX-20-20	1.25	1-1/4 -11	3.66	1.81	0.41	1.81	1.97

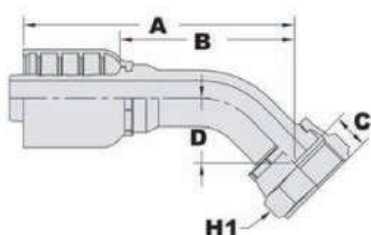

**Product Number:** SS-FBX45

**Name:** BSP 45° Female Swivel Elbow - Stainless

**Material:** 316 Stainless Steel

**Uses:** 1 & 2 Braided Hose

**Hoses:** 1SN (100R1), 2SN (100R2), R16, R17

PART NUMBER	HOSE I.D. (INCHES)	THREAD	DIMENSIONS (INCHES)				H1
			A	B	C	D	
SS-43-FBX45-04-04	1/4	1/4 -19	2.28	1.50	0.17	0.67	0.75
SS-43-FBX45-06-06	3/8	3/8 -19	2.80	1.73	0.24	0.75	0.87
SS-43-FBX45-08-08	1/2	1/2 -14	3.31	2.05	0.26	0.91	1.06
SS-43-FBX45-10-10	5/8	5/8 -14	3.62	2.09	0.30	0.83	1.06
SS-43-FBX45-12-12	3/4	3/4 -14	4.61	3.03	0.35	1.18	1.42
SS-43-FBX45-16-16	1	1 -11	4.92	3.15	0.42	1.73	1.61

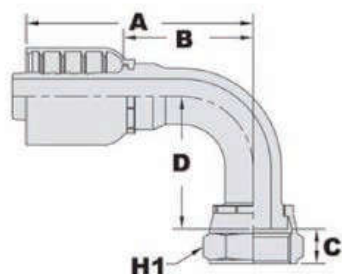

**Product Number:** SS-FBX90

**Name:** BSP Female Swivel, 90 Elbow - Stainless

**Material:** 316 Stainless Steel

**Uses:** 1 & 2 Braided Hose

**Hoses:** 1SN (100R1), 2SN (100R2), R16, R17

PART NUMBER	HOSE I.D. (INCHES)	THREAD	DIMENSIONS (INCHES)				H1
			A	B	C	D	
SS-43-FBX90-04-04	1/4	1/4 -19	2.01	1.18	0.17	1.10	0.75
SS-43-FBX90-06-06	3/8	3/8 -19	2.72	1.65	0.24	1.26	0.87
SS-43-FBX90-08-08	1/2	1/2 -14	2.76	1.50	0.26	1.38	1.06
SS-43-FBX90-12-12	3/4	3/4 -14	3.98	2.40	0.35	2.13	1.42
SS-43-FBX90-16-16	1	1 -11	4.96	3.19	0.42	2.56	1.61
SS-43-FBX90-20-20	1.25	1-1/4 -11	5.51	3.66	0.41	3.39	1.97

# 43 SERIES

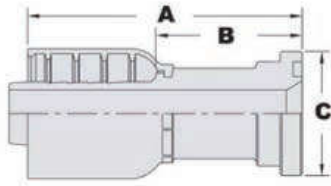

**Product Number:** SS-43-FL61  
**Name:** Code 61 Flange Rigid  
**Material:** 316 Stainless Steel  
**Uses:** 1 & 2 Braided Hose  
**Hoses:** 1SN (100R1), 2SN (100R2), R16, R17

PART NUMBER	HOSE I.D. (INCHES)	THREAD	DIMENSIONS (INCHES)		
			A	B	C
SS-43-C61-08-08	1/2	-	2.99	1.77	1.19
SS-43-C61-08-12	1/2	-	2.99	1.77	1.50
SS-43-C61-12-12	3/4	-	3.31	1.77	1.50
SS-43-C61-12-16	3/4	-	3.15	1.61	1.75
SS-43-C61-16-16	1	-	3.98	2.20	1.75
SS-43-C61-16-20	1	-	3.90	2.13	2.00
SS-43-C61-20-20	1.25	-	4.33	2.48	2.00
SS-43-C61-20-24	1.25	-	4.57	2.72	2.37
SS-43-C61-24-24	1.5	-	5.16	2.83	2.37
SS-43-C61-24-32	1.5	-	5.43	3.11	2.81
SS-43-C61-32-32	2	-	5.91	3.11	2.81

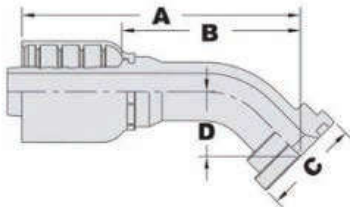

**Product Number:** SS-43-FL6145  
**Name:** Code 61 Flange Rigid, 45°  
**Material:** 316 Stainless Steel  
**Uses:** 1 & 2 Braided Hose  
**Hoses:** 1SN (100R1), 2SN (100R2), R16, R17

PART NUMBER	HOSE I.D. (INCHES)	THREAD	DIMENSIONS (INCHES)			
			A	B	C	D
SS-43-C6145-08-08	1/2	-	3.15	1.89	1.19	0.75
SS-43-C6145-08-12	1/2	-	3.27	2.01	1.50	0.87
SS-43-C6145-12-12	3/4	-	4.57	2.99	1.50	1.14
SS-43-C6145-12-16	3/4	-	4.57	2.99	1.75	1.14
SS-43-C6145-16-16	1	-	4.41	3.03	1.75	1.22
SS-43-C6145-16-20	1	-	4.41	3.03	2.00	1.22
SS-43-C6145-20-20	1.25	-	5.83	3.98	2.00	1.50
SS-43-C6145-20-24	1.25	-	5.91	4.06	2.37	1.57
SS-43-C6145-24-24	1.5	-	6.81	4.45	2.37	1.73
SS-43-C6145-32-24	1.5	-	6.81	4.45	2.81	1.73
SS-43-C6145-32-32	2	-	8.23	5.43	2.81	2.36

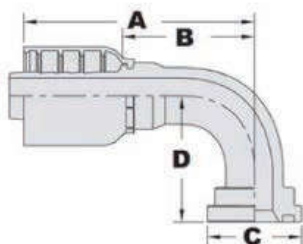

**Product Number:** SS-43-FL6190

**Name:** Code 61 Flange Rigid, 90°

**Material:** 316 Stainless Steel

**Uses:** 1 & 2 Braided Hose

**Hoses:** 1SN (100R1), 2SN (100R2), R16, R17

PART NUMBER	HOSE I.D. (INCHES)	THREAD	DIMENSIONS (INCHES)			
			A	B	C	D
SS-43-C6190-08-08	1/2	-	2.76	1.50	0.81	1.34
SS-43-C6190-08-12	1/2	-	2.76	1.50	1.50	1.38
SS-43-C6190-08-16	1	-	2.76	1.50	1.75	1.38
SS-43-C6190-10-12	5/8	-	2.80	1.65	1.50	1.65
SS-43-C6190-12-12	3/4	-	3.98	2.40	1.50	2.13
SS-43-C6190-12-16	3/4	-	3.98	2.40	1.75	2.13
SS-43-C6190-16-16	1	-	4.96	3.19	1.75	2.44
SS-43-C6190-16-20	1	-	4.96	3.19	2.00	2.44
SS-43-C6190-20-20	1.25	-	5.51	3.66	2.00	3.11
SS-43-C6190-20-24	1.25	-	5.51	3.66	2.37	3.19
SS-43-C6190-24-24	1.5	-	5.94	3.58	2.37	3.27
SS-43-C6190-24-32	1.5	-	5.94	3.58	2.81	3.27
SS-43-C6190-32-32	2	-	8.11	5.31	2.81	5.16

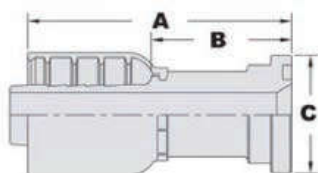

**Product Number:** SS-43-FL62

**Name:** Code 62 Flange Rigid

**Material:** 316 Stainless Steel

**Uses:** 1 & 2 Braided Hose

**Hoses:** 1SN (100R1), 2SN (100R2), R16, R17

PART NUMBER	HOSE I.D. (INCHES)	THREAD	DIMENSIONS (INCHES)		
			A	B	C
SS-43-C62-12-12	3/4	-	3.46	1.93	1.62
SS-43-C62-12-16	3/4	-	3.90	2.36	1.87
SS-43-C62-16-16	1	-	4.21	2.44	1.87
SS-43-C62-16-20	1	-	4.37	2.91	2.12
SS-43-C62-20-20	1.25	-	4.41	2.95	2.12
SS-43-C62-20-24	1.25	-	4.41	2.95	2.50
SS-43-C62-24-24	1.5	-	5.51	3.19	2.50
SS-43-C62-24-32	1.5	-	6.30	3.98	3.12
SS-43-C62-32-32	2	-	6.77	3.98	3.12

# 43 SERIES

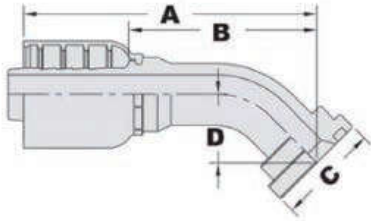

**Product Number:** SS-43-FL6245

**Name:** Code 62 Flange Rigid, 45°

**Material:** 316 Stainless Steel

**Uses:** 1 & 2 Braided Hose

**Hoses:** 1SN (100R1), 2SN (100R2), R16, R17

PART NUMBER	HOSE I.D. (INCHES)	THREAD	DIMENSIONS (INCHES)			
			A	B	C	D
SS-43-C6245-12-12	3/4	-	4.69	3.11	1.62	1.26
SS-43-C6245-16-16	1	-	4.61	3.23	1.87	1.42
SS-43-C6245-20-20	1.25	-	6.14	4.29	2.12	1.81
SS-43-C6245-24-24	1.5	-	7.05	4.69	2.50	1.97
SS-43-C6245-32-32	2	-	8.82	6.02	3.12	2.95

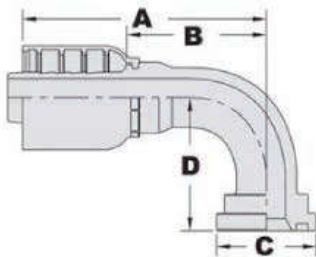

**Product Number:** SS-43-FL6290

**Name:** Code 62 Flange Rigid, 90°

**Material:** 316 Stainless Steel

**Uses:** 1 & 2 Braided Hose

**Hoses:** 1SN (100R1), 2SN (100R2), R16, R17

PART NUMBER	HOSE I.D. (INCHES)	THREAD	DIMENSIONS (INCHES)			
			A	B	C	D
SS-43-C6290-12-12	3/4	-	3.98	3.11	1.62	2.28
SS-43-C6290-16-16	1	-	4.96	3.23	1.87	2.72
SS-43-C6290-20-20	1.25	-	5.51	4.29	2.12	3.54
SS-43-C6290-24-24	1.5	-	5.94	4.69	2.50	3.62
SS-43-C6290-32-32	2	-	8.11	6.02	3.12	6.02

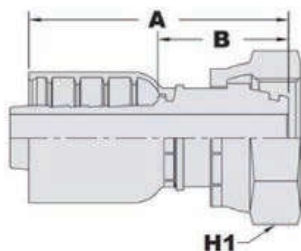

**Product Number:** SS-43-FDL

**Name:** Metric DIN Light

**Material:** 316 Stainless Steel

**Uses:** 1 & 2 Braided Hose

**Hoses:** 1SN (100R1), 2SN (100R2), R16, R17

PART NUMBER	HOSE I.D. (INCHES)	THREAD	DIMENSIONS (INCHES)		H1	TUBE (MM)
			A	B		
SS-43-FDL-04-08-14	1/4	M14 X 1.5	1.89	1.10	0.75	8
SS-43-FDL-04-10-16	1/4	M16 X 1.5	1.89	1.10	0.88	10
SS-43-FDL-06-10-16	3/8	M16 X 1.5	2.32	1.26	0.88	10
SS-43-FDL-06-12-18	3/8	M18 X 1.5	2.28	1.22	0.94	12
SS-43-FDL-08-15-22	1/2	M22 X 1.5	2.60	1.38	1.06	15
SS-43-FDL-10-18-26	5/8	M26 X 1.5	3.03	1.54	1.26	18
SS-43-FDL-12-22-30	3/4	M30 X 2.0	3.15	1.61	1.42	22
SS-43-FDL-16-28-36	1	M36 X 2.0	3.58	1.81	1.81	28
SS-43-FDL-20-35-45	1.25	M45 X 2.0	4.02	2.17	2.17	35

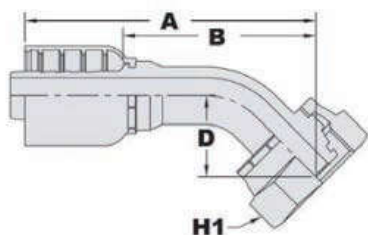

**Product Number:** SS-43-FDL45

**Name:** Metric DIN Light, 45°

**Material:** 316 Stainless Steel

**Uses:** 1 & 2 Braided Hose

**Hoses:** 1SN (100R1), 2SN (100R2), R16, R17

PART NUMBER	HOSE I.D. (INCHES)	THREAD	DIMENSIONS (INCHES)			H1	TUBE (MM)
			A	B	D		
SS-43-FDL45-04-06-12	1/4	M12 X 1.5	2.24	1.42	0.59	0.67	6
SS-43-FDL45-04-08-14	1/4	M14 X 1.5	2.36	1.54	0.71	0.75	8
SS-43-FDL45-04-10-16	1/4	M16 X 1.5	2.44	1.61	0.75	0.87	10
SS-43-FDL45-06-10-16	3/8	M16 X 1.5	2.87	1.81	0.83	0.87	10
SS-43-FDL45-06-12-18	3/8	M18 X 1.5	2.87	1.81	0.83	0.94	12
SS-43-FDL45-08-15-22	1/2	M22 X 1.5	3.43	2.17	1.10	1.06	15
SS-43-FDL45-10-18-26	5/8	M26 X 1.5	4.02	2.48	1.18	1.26	18
SS-43-FDL45-12-15-26	3/4	M26 X 1.5	4.92	3.35	1.50	1.26	18
SS-43-FDL45-12-22-30	3/4	M30 X 2.0	4.84	3.27	1.42	1.42	22
SS-43-FDL45-12-28-36	3/4	M36 X 2.0	4.84	3.27	1.42	1.81	28
SS-43-FDL45-16-28-36	1	M36 X 2.0	5.08	3.31	1.46	1.81	28
SS-43-FDL45-20-35-45	1.25	M45 X 2.0	6.18	4.33	1.85	2.17	35
SS-43-FDL45-24-42-52	1.5	M52 X 2.0	7.09	4.72	2.48	2.36	42

# 43 SERIES

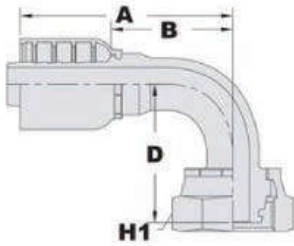

**Product Number:** SS-43-FDL90  
**Name:** Metric DIN Light, 90°  
**Material:** 316 Stainless Steel  
**Uses:** 1 & 2 Braided Hose  
**Hoses:** 1SN (100R1), 2SN (100R2), R16, R17

PART NUMBER	HOSE I.D. (INCHES)	THREAD	DIMENSIONS (INCHES)			H1	TUBE (MM)
			A	B	D		
SS-43-FDL90-04-06-12	1/4	M12 X 1.5	2.01	1.18	1.02	0.67	6
SS-43-FDL90-04-08-14	1/4	M14 X 1.5	2.01	1.18	1.18	0.75	8
SS-43-FDL90-04-10-16	1/4	M16 X 1.5	2.01	1.18	1.22	0.87	10
SS-43-FDL90-06-10-16	3/8	M16 X 1.5	2.72	1.65	1.26	0.87	10
SS-43-FDL90-06-12-18	3/8	M18 X 1.5	2.72	1.65	1.30	0.94	12
SS-43-FDL90-08-15-22	1/2	M22 X 1.5	2.76	1.50	1.46	1.06	15
SS-43-FDL90-10-18-26	5/8	M26 X 1.5	2.80	1.65	2.01	1.26	18
SS-43-FDL90-12-18-26	3/4	M26 X 1.5	3.98	2.40	2.48	1.26	18
SS-43-FDL90-12-22-30	3/4	M30 X 2.0	3.98	2.40	2.40	1.42	22
SS-43-FDL90-12-28-36	3/4	M36 X 2.0	3.98	2.40	2.40	1.81	28
SS-43-FDL90-16-28-36	1	M36 X 2.0	4.96	3.19	2.68	1.81	28
SS-43-FDL90-20-35-45	1.25	M45 X 2.0	5.51	3.66	3.43	2.17	35
SS-43-FDL90-24-42-52	1.5	M52 X 2.0	5.94	3.58	3.58	2.36	42

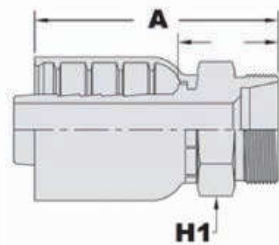

**Product Number:** SS-43-MDL  
**Name:** Male Metric DIN Light  
**Material:** 316 Stainless Steel  
**Uses:** 1 & 2 Braided Hose  
**Hoses:** 1SN (100R1), 2SN (100R2), R16, R17

PART NUMBER	HOSE I.D. (INCHES)	THREAD	DIMENSIONS (INCHES)		H1
			A	B	
SS-43-MDL-04-14	1/4	M14 X 1.5	1.65	0.87	0.67
SS-43-MDL-06-16	3/8	M16 X 1.5	1.97	0.91	0.67
SS-43-MDL-06-18	3/8	M18 X 1.5	2.01	0.94	0.75
SS-43-MDL-08-22	1/2	M22 X 1.5	2.20	0.98	0.87
SS-43-MDL-10-26	5/8	M26 X 1.5	2.52	1.02	1.06
SS-43-MDL-12-30	3/4	M30 X 2.0	2.68	1.14	1.18
SS-43-MDL-16-36	1	M36 X 2.0	2.99	1.22	1.42
SS-43-MDL-20-45	1.25	M45 X 2.0	3.46	1.61	1.81



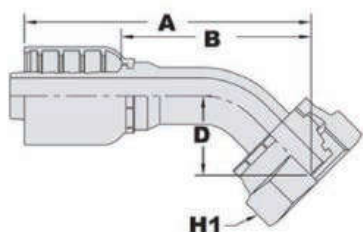

**Product Number:** SS-43-FDS45

**Name:** Metric DIN Heavy, 45°

**Material:** 316 Stainless Steel

**Uses:** 1 & 2 Braided Hose

**Hoses:** 1SN (100R1), 2SN (100R2), R16, R1

PART NUMBER	HOSE I.D. (INCHES)	THREAD	DIMENSIONS (INCHES)			H1	TUBE (MM)
			A	B	D		
SS-43-FDS45-04-10-18	1/4	M18 X 1.5	2.52	1.69	0.83	0.94	10
SS-43-FDS45-06-10-18	3/8	M18 X 1.5	2.95	1.89	0.91	0.94	10
SS-43-FDS45-06-12-20	3/8	M20 X 1.5	2.95	1.89	0.91	0.94	12
SS-43-FDS45-06-14-22	3/8	M22 X 1.5	2.95	1.89	0.91	1.06	14
SS-43-FDS45-08-16-24	1/2	M24 X 1.5	3.50	2.24	1.18	1.26	16
SS-43-FDS45-10-20-30	5/8	M30 X 2.0	3.94	2.40	1.10	1.42	20
SS-43-FDS45-12-20-30	3/4	M30 X 2.0	4.84	3.27	1.42	1.42	20
SS-43-FDS45-12-25-36	3/4	M36 X 2.0	4.88	3.31	1.46	1.81	25
SS-43-FDS45-16-25-36	1	M36 X 2.0	5.12	3.35	1.50	1.81	25
SS-43-FDS45-16-30-42	1	M42 X 2.0	5.12	3.35	1.50	1.97	30
SS-43-FDS45-20-38-52	1.25	M52 X 2.0	6.22	4.37	1.89	2.36	38
SS-43-FDS45-24-38-52	1.5	M52 X 2.0	7.05	4.69	2.44	2.36	38

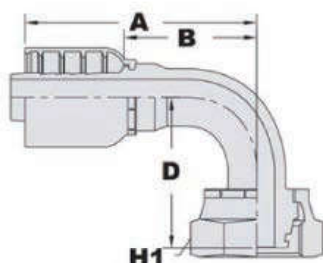

**Product Number:** SS-43-FDS90

**Name:** Metric DIN Heavy, 90°

**Material:** 316 Stainless Steel

**Uses:** 1 & 2 Braided Hose

**Hoses:** 1SN (100R1), 2SN (100R2), R16, R17

PART NUMBER	HOSE I.D. (INCHES)	THREAD	DIMENSIONS (INCHES)			H1	TUBE (MM)
			A	B	D		
SS-43-FDS90-04-10-18	1/4	M18 X 1.5	2.01	1.18	1.34	0.94	10
SS-43-FDS90-06-10-18	3/8	M18 X 1.5	2.72	1.65	1.38	0.94	10
SS-43-FDS90-06-12-20	3/8	M20 X 1.5	2.72	1.65	1.38	0.94	12
SS-43-FDS90-06-14-22	3/8	M22 X 1.5	2.72	1.65	1.42	1.06	14
SS-43-FDS90-08-16-24	1/2	M24 X 1.5	2.76	1.50	1.57	1.26	16
SS-43-FDS90-10-20-30	5/8	M30 X 2.0	2.80	1.65	1.93	1.42	20
SS-43-FDS90-12-20-30	3/4	M30 X 2.0	3.98	2.40	2.40	1.42	20
SS-43-FDS90-12-25-36	3/4	M36 X 2.0	3.98	2.40	2.44	1.81	25
SS-43-FDS90-16-25-36	1	M36 X 2.0	4.96	3.19	2.72	1.81	25
SS-43-FDS90-16-30-42	1	M42 X 2.0	4.96	3.19	2.76	1.97	30
SS-43-FDS90-20-38-52	1.25	M52 X 2.0	5.51	3.66	3.39	2.56	38
SS-43-FDS90-24-38-52	1.5	M52 X 2.0	5.94	3.58	3.54	2.56	38

# 43 SERIES

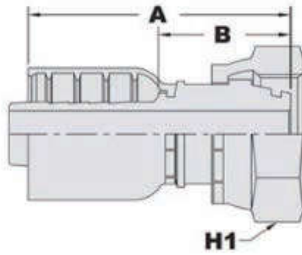

**Product Number:** SS-43-FDS  
**Name:** Metric DIN Light, 90°  
**Material:** 316 Stainless Steel  
**Uses:** 1 & 2 Braided Hose  
**Hoses:** 1SN (100R1), 2SN (100R2), R16, R17

PART NUMBER	HOSE I.D. (INCHES)	THREAD	DIMENSIONS (INCHES)		H1	TUBE (MM)
			A	B		
SS-43-FDS-04-10-18	1/4	M18 X 1.5	1.89	1.10	0.94	10
SS-43-FDS-06-10-18	3/8	M18 X 1.5	2.32	1.26	0.94	10
SS-43-FDS-06-12-20	3/8	M20 X 1.5	2.32	1.26	0.94	12
SS-43-FDS-06-14-22	3/8	M22 X 1.5	2.32	1.26	1.06	14
SS-43-FDS-08-16-24	1/2	M24 X 1.5	2.60	1.38	1.26	16
SS-43-FDS-10-20-30	5/8	M30 X 2.0	3.03	1.54	1.42	20
SS-43-FDS-12-25-36	3/4	M36 X 2.0	3.15	1.61	1.81	25
SS-43-FDS-16-25-36	1	M36 X 2.0	3.58	1.81	1.81	25
SS-43-FDS-16-30-42	1	M42 X 2.0	3.58	1.81	1.97	30
SS-43-FDS-20-38-52	1.25	M52 X 2.0	4.02	2.17	2.36	38
SS-43-FDS-24-38-52	1.5	M52 X 2.0	4.76	2.44	2.36	38

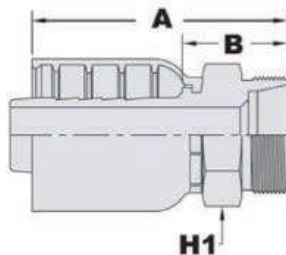

**Product Number:** SS-43-MDS  
**Name:** Male Metric DIN Heavy  
**Material:** 316 Stainless Steel  
**Uses:** 1 & 2 Braided Hose  
**Hoses:** 1SN (100R1), 2SN (100R2), R16, R17

PART NUMBER	HOSE I.D. (INCHES)	THREAD	DIMENSIONS (INCHES)		H1
			A	B	
SS-43-MDS-04-16	1/4	M16 X 1.5	1.65	0.87	0.67
SS-43-MDS-04-18	1/4	M18 X 1.5	1.65	0.87	0.75
SS-43-MDS-06-18	3/8	M18 X 1.5	1.97	0.91	0.75
SS-43-MDS-06-20	3/8	M20 X 1.5	1.97	0.91	0.87
SS-43-MDS-06-22	3/8	M22 X 1.5	2.17	0.94	0.87
SS-43-MDS-08-24	1/2	M24 X 1.5	2.20	0.98	1.18
SS-43-MDS-10-30	5/8	M30 X 2.0	2.52	1.02	1.18
SS-43-MDS-12-36	3/4	M36 X 2.0	2.68	1.14	1.42
SS-43-MDS-16-45	1	M45 X 2.0	2.99	1.22	1.81
SS-43-MDS-20-52	1.25	M52 X 2.0	3.46	1.61	2.17